

KEITHLEY INSTRUMENTS

Model 3940 Multifunction Synthesizer Operator's Manual

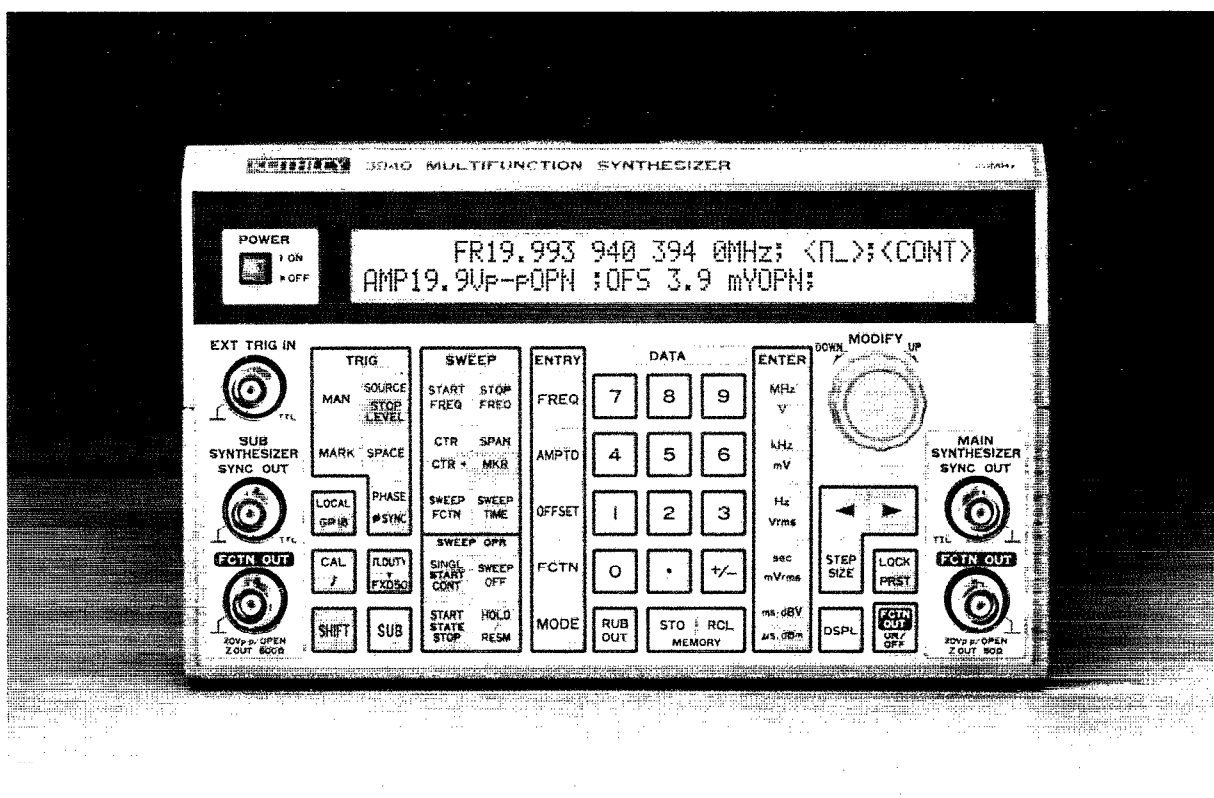

Contains Operating Information

Publication Date: March 1991

Document Number: 3940-900-01 Rev. A

WARRANTY

Keithley Instruments, Inc. warrants this product to be free from defects in material and workmanship for a period of 1 year from date of shipment.

Keithley Instruments, Inc. warrants the following items for 90 days from the date of shipment: probes, cables, rechargeable batteries, diskettes, and documentation.

During the warranty period, we will, at our option, either repair or replace any product that proves to be defective.

To exercise this warranty, write or call your local Keithley representative, or contact Keithley headquarters in Cleveland, Ohio. You will be given prompt assistance and return instructions. Send the product, transportation prepaid, to the indicated service facility. Repairs will be made and the product returned, transportation prepaid. Repaired or replaced products are warranted for the balance of the original warranty period, or at least 90 days.

LIMITATION OF WARRANTY

This warranty does not apply to defects resulting from product modification without Keithley's express written consent, or misuse of any product or part. This warranty also does not apply to fuses, software, non-rechargeable batteries, damage from battery leakage, or problems arising from normal wear or failure to follow instructions.

THIS WARRANTY IS IN LIEU OF ALL OTHER WARRANTIES, EXPRESSED OR IMPLIED, INCLUDING ANY IMPLIED WARRANTY OF MERCHANTABILITY OR FITNESS FOR A PARTICULAR USE. THE REMEDIES PROVIDED HEREIN ARE BUYER'S SOLE AND EXCLUSIVE REMEDIES.

NEITHER KEITHLEY INSTRUMENTS, INC. NOR ANY OF ITS EMPLOYEES SHALL BE LIABLE FOR ANY DIRECT, INDIRECT, SPECIAL, INCIDENTAL OR CONSEQUENTIAL DAMAGES ARISING OUT OF THE USE OF ITS INSTRUMENTS AND SOFTWARE EVEN IF KEITHLEY INSTRUMENTS, INC., HAS BEEN ADVISED IN ADVANCE OF THE POSSIBILITY OF SUCH DAMAGES. SUCH EXCLUDED DAMAGES SHALL INCLUDE, BUT ARE NOT LIMITED TO: COSTS OF REMOVAL AND INSTALLATION, LOSSES SUSTAINED AS THE RESULT OF INJURY TO ANY PERSON, OR DAMAGE TO PROPERTY.

KEITHLEY INSTRUMENTS

Instruments Division, Keithley Instruments, Inc. • 28775 Aurora Road • Cleveland, Ohio 44139 • (216) 248-0400 • Fax: 248-6168

WEST GERMANY: Keithley Instruments GmbH • Heighofstr. 5 • Munchen 70 • 089-71002-0 • Telex: 52-12160 • Fax: 089-7100259
GREAT BRITAIN: Keithley Instruments, Ltd. • The Minster • 58, Portman Road • Reading, Berkshire RG 3 1EA • 011 44 734 575 666 • Fax: 011 44 734 596 469
FRANCE: Keithley Instruments SARL • 3 Allee des Garays • B.P. 60 • 91124 Palaiseau/Z.I. • 1-6-0115 155 • Telex: 600 933 • Fax: 1-6-0117726
NETHERLANDS: Keithley Instruments BV • Avelingen West 49 • 4202 MS Gorinchem • P.O. Box 559 • 4200 AN Gorinchem • 01830-35333 • Telex: 24 684 • Fax: 01830-30821
SWITZERLAND: Keithley Instruments SA • Kriesbachstr. 4 • 8600 Dubendorf • 01-821-9444 • Telex: 828 472 • Fax: 0222-315366
AUSTRIA: Keithley Instruments GesmbH • Rosenhugelstrasse 12 • A-1120 Vienna • (0222) 84 65 48 • Telex: 131677 • Fax: (0222) 8403597
ITALY: Keithley Instruments SRL • Viale S. Gimignano 4/A • 20146 Milano • 02-4120360 or 02-4156540 • Fax: 02-4121249

**Operator's Manual
Model 3940
Multifunction Synthesizer**

**©1991, Keithley Instruments, Inc.
All Rights Reserved
Instruments Division
Cleveland, Ohio, U. S. A.
Document Number: 3940-900-01**

All Keithley product names are trademarks or registered trademarks of Keithley Instruments, Inc.
Other brand and product names are trademarks or registered trademarks of their respective holders.

Safety Precautions

The following safety precautions should be observed before using the Model 3940 Multifunction Synthesizer and any associated instruments.

This instrument is intended for use by qualified personnel who recognize shock hazards and are familiar with the safety precautions required to avoid possible injury. Read over this manual carefully before using the instrument.

Exercise extreme caution when a shock hazard is present at the test circuit. The American National Standards Institute (ANSI) states that a shock hazard exists when voltage levels greater than 30V rms or 42.4V peak are present. **A good safety practice is to expect that hazardous voltage is present in any unknown circuit before measuring.**

Inspect the connecting cables and test leads for possible wear, cracks, or breaks before each use.

For maximum safety, do not touch the test cables or any instruments while power is applied to the circuit under test. Turn off the power and discharge any capacitors before connecting or disconnecting cables from the instrument.

Do not touch any object which could provide a current path to the common side of the circuit under test or power line (earth) ground. Always make measurements with dry hands while standing on a dry, insulated surface capable of withstanding the voltage being measured.

Instrumentation and accessories should not be connected to humans.

Table of Contents

SECTION 1 — General Information

1.1	INTRODUCTION	1-1
1.2	FEATURES	1-1
1.3	WARRANTY INFORMATION	1-2
1.4	MANUAL ADDENDA	1-2
1.5	SAFETY TERMS AND SYMBOLS	1-2
1.6	UNPACKING AND REPACKING	1-2
1.6.1	Unpacking	1-2
1.6.2	Shipment Contents	1-2
1.6.3	Operator's Manual	1-2
1.6.4	Repacking For Shipment	1-2
1.7	OPTIONAL ACCESSORIES	1-3
1.8	SPECIFICATIONS	1-3

SECTION 2 — Getting Started

2.1	INTRODUCTION	2-1
2.2	INSTALLATION	2-1
2.2.1	Installation Location	2-1
2.2.2	Fan	2-1
2.3	LINE VOLTAGE SUPPLY	2-2
2.3.1	Line Voltage Selector Switch	2-2
2.3.2	Line Receptacle Connection	2-2
2.3.3	Line Fuse	2-2
2.4	HANDLING PRECAUTIONS	2-3
2.5	BASIC OPERATION	2-3
2.5.1	Front Panel Summary	2-3
2.5.2	Typical Test Connections	2-3
2.5.3	Operating Examples	2-5

SECTION 3 — Operation

3.1	INTRODUCTION	3-1
3.2	FRONT PANEL AND REAR PANEL DESCRIPTION	3-1
3.2.1	Front Panel Description	3-1
3.2.2	Rear Panel Description	3-12
3.3	Input and Output Connections	3-14
3.3.1	Input Connections	3-14
3.3.2	Output Connections	3-15
3.4	STARTUP	3-16
3.5	OPERATING PROCEDURES	3-17
3.5.1	Setting Parameters Using Numeric Keys	3-17

3.5.2	Setting Parameters with MODIFY	3-18
3.5.3	Error Codes	3-18
3.5.4	Units Conversion	3-22
3.5.5	Frequency Programming	3-22
3.5.6	Amplitude Programming	3-23
3.5.7	DC Offset Programming	3-23
3.5.8	AC Amplitude and DC Offset Relational Restrictions	3-24
3.5.9	Waveform Selection, Square-Wave Duty Factor, and Synchronous Output	3-26
3.5.10	Oscillation Mode and Trigger Source Selection	3-28
3.5.11	Mark, Space, and Phase Parameter Programming	3-29
3.5.12	Stop Level and ϕ SYNC	3-32
3.5.13	Synchronous Operation	3-34
3.5.14	Frequency Sweep Operation	3-34

SECTION 4 — GPIB Interface

4.1	INTRODUCTION	4-1
4.1.1	GPIB Overview	4-1
4.1.2	Major GPIB Specifications	4-1
4.1.3	Bus Line Signals and Operation	4-2
4.1.4	GPIB Handshaking	4-2
4.1.5	Data Transfer Example	4-3
4.1.6	Basic Talker Functions	4-3
4.1.7	Basic Listener Functions	4-4
4.1.8	Basic Controller Functions	4-4
4.1.9	Multi-Line Interface Messages	4-4
4.2	OVERVIEW OF MODEL 3940 GPIB INTERFACE	4-6
4.2.1	Introduction	4-6
4.2.2	Specifications	4-6
4.3	MODEL 3940 PROGRAM CODES	4-13
4.3.1	Model 3940 Parameter-Setting Messages	4-13
4.3.2	Model 3940 Inquiry Messages	4-26
4.4	TYPICAL EXECUTION TIMES	4-35
4.5	PROGRAM CODE SUMMARY TABLE	4-40
4.6	SAMPLE PROGRAMS	4-45

List of Illustrations

SECTION 2 — Getting Started

Figure 2-1	Front Panel Summary	2-4
Figure 2-2	Typical Test Connections	2-5

SECTION 3 — Operation

Figure 3-1	Front Panel	3-2
Figure 3-2	Rear Panel	3-12
Figure 3-3	Logic Input Circuits	3-14
Figure 3-4	Analog Input Circuit	3-14
Figure 3-5	Main Synthesizer Sync Output	3-15
Figure 3-6	Sub Synthesizer Sync Output	3-15
Figure 3-7	Sweep Marker and Sync Outputs	3-15
Figure 3-8	Relational Range for Allowed AC Amplitude Voltage and DC Offset Voltage	3-25
Figure 3-9	Phase Relationship Between Waveform and Synchronous Output	3-27
Figure 3-10	BURST Oscillation	3-28
Figure 3-11	Trigger Oscillation	3-29
Figure 3-12	Gate Oscillation	3-29
Figure 3-13	Waveforms and Phase Definitions	3-31
Figure 3-14	Waveform Examples with Hold Stop Level	3-32
Figure 3-15	Waveform Examples with Reset Stop Level	3-32
Figure 3-16	Phase Sync Operation	3-33
Figure 3-17	Phase Relationship after Phase Sync	3-33
Figure 3-18	Sweep Frequency and Sweep Output	3-36
Figure 3-19	Sweep Operation	3-37

SECTION 4 — GPIB Interface

Figure 4-1	Interface Connector	4-2
Figure 4-2	Handshake Timing Diagram	4-3
Figure 4-3	Data Transfer Example	4-4
Figure 4-4	Program Code Syntax	4-7
Figure 4-5	Response Output Format	4-9

List of Tables

SECTION 2 — Getting Started

Table 2-1	Fuse Replacement	2-3
-----------	------------------------	-----

SECTION 3 — Operation

Table 3-1	Main Synthesizer Amplitude Range	3-20
Table 3-2	Sub Synthesizer Amplitude Range	3-20

SECTION 4 — GPIB Interface

Table 4-1	Multi-Line Interface Messages	4-5
Table 4-2	Interface Functions	4-6
Table 4-3	Bus Driver Specifications	4-6
Table 4-4	Responses to Interface Messages	4-7
Table 4-5	Status Byte	4-12
Table 4-6	Main Synthesizer Parameter Setting Messages	4-13
Table 4-7	Sub Synthesizer Parameter Setting Messages	4-16
Table 4-8	Main Synthesizer Trigger Parameter Setting Messages	4-18
Table 4-9	Main Synthesizer Sweep Parameter Setting Messages	4-20
Table 4-10	Miscellaneous Parameter Messages	4-23
Table 4-11	ARB Waveform Write and Readout Messages	4-24
Table 4-12	Parameters Specific to GPIB	4-25
Table 4-13	Main Synthesizer Parameter Inquiry Messages	4-26
Table 4-14	Sub Synthesizer Parameter Inquiry Messages	4-28
Table 4-15	Main Synthesizer Trigger Parameter Inquiry Messages	4-29
Table 4-16	Main Synthesizer Sweep Parameter Inquiry Messages	4-30
Table 4-17	Inquiry Messages for Miscellaneous Parameters	4-32
Table 4-18	Inquiry Messages for ARB Waveform Write and Readout Parameters	4-33
Table 4-19	Inquiry Messages for Parameters Specific to GPIB	4-34
Table 4-20	Typical Execution Times	4-35
Table 4-21	Program Codes Summary	4-40

SECTION 1

General Information

1.1 INTRODUCTION

The Model 3940 Multifunction Synthesizer is a multi-function oscillator integrated with two frequency synthesizers: the 0Hz to 20MHz main synthesizer and the 0Hz to 100kHz sub synthesizer. The Model 3940 can generate the entire frequency band at a resolution of 0.1mHz, with an accuracy of ± 5 ppm.

Five output waveforms, \sim , \sphericalangle , \square , \sphericalangle , and \sphericalangle , are available. In addition, arbitrary waveforms set with the GPIB (IEEE-488) interface can be generated by the main synthesizer. Maximum output voltage for all waveforms is 20V p-p (no load).

Since frequencies are synthesized directly by a custom LSI digital IC, accuracy and stability are high, and the frequency switching time is short. Another advantage is the continuity of phase at frequency switchover.

Frequency sweep, half-cycle unit bursts of up to 32,768 cycles, trigger oscillation, and gate oscillation are available with the main synthesizer. The square-wave duty cycle is also variable. In addition, external signals can be combined with the oscillator output to generate custom waveforms.

Frequency, amplitude, waveform, and phase can be independently set on the sub synthesizer, which is not dependent upon the main synthesizer. The sub synthesizer can also be used as a trigger oscillator for the main synthesizer.

Since the sub synthesizer and the main synthesizer use the same clock source, the phase will not deviate when the frequency is set with a whole number ratio.

The Model 3940 uses a two-line, 40-character liquid crystal display to display selected functions, parameters, and pertinent messages. Parameter settings are easily made using both the numeric keys and the modify knob.

The Model 3940 is equipped with a standard GPIB (IEEE-488) interface, and can be programmed over the bus for the same operating modes and parameters that can be controlled from the front panel.

The Model 3940 can be used as a multiphase oscillator when combined with multiple identical units and used with the optional synchronous cable.



1.2 FEATURES

1. Two integrated independent frequency synthesizers: Main Synthesizer and Sub Synthesizer

2. Wide bandwidth; ± 5 ppm frequency accuracy; and phase continuity at frequency switchover.

Main Synthesizer: 0Hz to 20MHz
(resolution: 0.1mHz)

Sub Synthesizer: 0Hz to 100kHz
(resolution: 0.1mHz)

3. Five output waveforms available: , and , (sub synthesizer and main synthesizer); arbitrary waveforms, variable duty factor for square waves (main synthesizer only).
4. External signals can be added to the main synthesizer waveform output to synthesize additional waveforms.
5. Burst, trigger, gate oscillation, and frequency sweep function (main synthesizer only).
6. Multiphase oscillator operation with the use of the optional synchronous cable and additional Model 3940 units.

1.3 WARRANTY INFORMATION

Warranty information is located on the inside front cover of this operator's manual. Should your Model 3940 require warranty service, contact the Keithley representative or authorized repair facility in your area for further information. When returning the instrument for repair, be sure to fill out and include the service form at the back of this manual in order to provide the repair facility with the necessary information.

1.4 MANUAL ADDENDA

Any improvements or changes concerning the instrument or manual will be explained in an addendum included with the unit. Be sure to note these changes and incorporate them into the manual before using the unit.

1.5 SAFETY TERMS AND SYMBOLS

The following safety terms and symbols are found on the instrument or used in this manual.

The  symbol on the instrument indicates that the user should refer to the operating instructions.

The **WARNING** heading used in this manual explains dangers that might result in personal injury or death. Always read the associated information very carefully before performing the indicated procedure.

The **CAUTION** heading used in this manual explains hazards that could damage the instrument card. Such damage may invalidate the warranty.

1.6 UNPACKING AND REPACKING

1.6.1 Unpacking

After carefully unpacking the instrument from its shipping carton, inspect it for any obvious signs of physical damage. Report any such damage to the shipping agent immediately. Save the original packing carton for storage or possible future shipment.

1.6.2 Shipment Contents

The following items are included with every Model 3940 order:

- Model 3940 Multifunction Synthesizer
- Model 3940 Operator's Manual.
- Power cord
- Fuse 2A, 250V, 5.2 x 20mm (contained in fuse holder as spare fuse)
- BNC to BNC signal cable
- Additional accessories as ordered.

1.6.3 Operator's Manual

If an additional manual is required, order the manual package, Keithley part number 3940-900-00. The manual package includes an operator's manual and any pertinent addenda.

1.6.4 Repacking For Shipment

Should it become necessary to return the Model 3940 for repair, carefully pack the unit in its original packing carton or the equivalent. Be sure to use a cardboard box of sufficient strength.

Include the following information:

- Advise as to the warranty status of the instrument.

- Write ATTENTION REPAIR DEPARTMENT on the shipping label.
- Fill out and include the service form located at the back of this manual.

1.7 OPTIONAL ACCESSORIES

The following accessories are available for use with the Model 3940.

Model 3949 Synchronous Cable: The Model 3949 allows multiple Model 3940 units to be connected together to form a multiphase oscillator.

Models 3900-1 and 3900-2 Rack Mounting Kits: The Model 3900-2 mounts one Model 3940 in a standard 19 inch rack. The Model 3900-1 mounts two Model 3940s side by side in a standard 19 inch rack. Both kits include all necessary hardware for proper rack mounting of the instruments.

Model 7007 Shielded IEEE-488 Cables: The Model 7007-1 (1m, 3.3ft.) and Model 7007-2 (2m, 6.6ft.) can be used to interface the Model 3940 to the IEEE-488 bus.

Model 7051-2 BNC-to-BNC Cable: The Model 7051-2 is 50 Ω BNC to BNC cable (RG-58C) 2ft. (0.6m) in length.

The Model 7051-2 is terminated with male BNC connectors on both ends.

Model 7051-5 BNC-to-BNC Cable: The Model 7051-5 is 50 Ω BNC to BNC cable (RG-58C) 5ft. (1.2m) in length. The Model 7051-5 is terminated with male BNC connectors on both ends.

Model 7051-10 BNC-to-BNC Cable: The Model 7051-10 is similar to the Models 7051-2 and 7051-5 except that it is 10ft. in length.

Model 7754-3 BNC-to-Alligator Cable: The Model 7754-3 is a 3ft. (0.9m) 50 Ω cable (RG-58C), terminated with a male BNC connector on one end and two alligator clips on the other end.

Model 7755 50 Ω Feed-Through Terminator: The Model 7755 is a BNC to BNC adapter that is terminated with a 50 Ω resistor. VSWR is <1.1, DC to 250MHz.

1.8 SPECIFICATIONS

Detailed Model 3940 specifications may be found in Appendix B.

SECTION 2

Getting Started

2.1 INTRODUCTION

This sections contains basic information on installation and power line connections; it also provides typical simple operating examples.

2.2 INSTALLATION

The following paragraphs discuss Model 3940 installation. In particular, use adequate care when installing the unit. Improper installation will adversely affect the life, reliability, and safety of the unit.

The Model 3940 weighs about 12 lbs. Be careful when carrying the unit or mounting it in a rack.

2.2.1 Installation Location

The allowable ambient temperature and humidity ranges for the Model 3940 are.

Operating: 0° to 40°C, 10 to 90%RH
Storage: -10° to 50°C, 10 to 80%RH

Be sure to install the unit in a location that satisfies these temperature and humidity conditions. Also the environment must be free of dust and vibration, and the Model 3940 must not be exposed to direct sunlight.

The Model 3940 uses a line filter, but pulse noise or strong magnetic or electric fields may cause incorrect operation of the unit. Do not install the unit near a source of pulse noise or strong magnetic or electric fields.

The guard on the rear panel of the unit is designed to protect rear panel connectors and should not be used as a leg for installation. Do not stand the unit vertically on the rear guard because it may fall over, causing instrument damage or personal injury.

2.2.2 Fan

The Model 3940 is air-cooled by a fan. Insufficient air flow may cause components in the unit to fail. Follow the instructions given below.

CAUTION

Observe the following precautions to prevent damage to the unit:

- An air intake port is provided on the rear panel of the unit. Allow a space of at least

four inches between the rear panel and a wall or other obstruction.

- An exhaust port is provided on the bottom panel of the unit. Install the unit on a rigid, flat surface, and avoid installing it on soft material such as a cushion. Be careful not to insert foreign material between the bottom of the unit and the surface underneath. Another exhaust port is located on the top panel of the unit. Be careful not to block the top port by placing an object on top of the unit.
- Avoid mounting two or more units vertically (for example, when using two or more units synchronously). Placing one unit on top of another will obstruct the exhaust port.
- Dust collecting in the fan filter will prevent sufficient air flow. In clean operating environments, wash the filter with a mild detergent every three months. When operating the unit in a dusty environment, wash the filter with a mild detergent at least once a month.
- Immediately turn off the power to the unit if the fan ceases to operate. Operating the instrument with the fan inoperative may result in damage to the instrument.

2.3 LINE VOLTAGE SUPPLY

The Model 3940 operates with a 100V, 120V, 220V, or 240V $\pm 10\%$, 48 to 62Hz, single-phase AC power supply. The power consumption is 84VA.

2.3.1 Line Voltage Selector Switch

The LINE VOLTAGE SELECTOR switch on the rear panel allows you to change operating voltage of the power supply. The standard setting of the switch is the same as the voltage available in the country to which the unit is shipped.

To change the power supply voltage, first disconnect the line cord, and set the supply voltage switch in the correct position. Wait at least five seconds before turning the power back on after turning it off.

WARNING

Disconnect the power cord from the instrument before changing the supply voltage setting.

CAUTION

Be sure to set the line voltage switch to the correct position for the line power voltage to be used. Operating the instrument on an incorrect voltage may cause damage to the unit.

2.3.2 Line Receptacle Connection

Connect the supplied power cord to the rear panel LINE receptacle and to a grounded AC power receptacle supplying the correct voltage.

WARNING

The Model 3940 is equipped with a 3-wire power cord that contains a separate ground wire and is designed to be used with grounded outlets. When proper connections are made, instrument chassis is connected to the power line ground. If the AC outlet is not grounded, the rear panel ground terminal  must be connected to safety earth ground using #18AWG (or larger) wire before use.

2.3.3 Line Fuse

The line fuse, which is integral with the power line receptacle, protects the instrument from over-current situations. To replace the fuse, first disconnect the line cord, then pry out the fuse compartment (immediately to the left of the FUSE marking) with a small screwdriver. A spare fuse is located in the compartment with the fuse being used. Replace the blown fuse only with the type listed in Table 2-1, then close the compartment.

WARNING

Disconnect the line cord from the instrument before replacing the fuse.

CAUTION

Use only a fuse of the rating listed in Table 2-1, or instrument damage may occur.

Table 2-1. Fuse Replacement

Line Voltage	Fuse Current Rating
110V, 120V	2A
220V, 240V	1A

2.4 HANDLING PRECAUTIONS

A flat keyboard coated with a polyester film forms the control panel surface of the Model 3940. Be careful not to damage the keyboard surface by cutting it with a sharp instrument or touching it with a hot object.

When the panel or case becomes dirty, clean it with a soft cloth. If the panel or case is too dirty for cleaning with a dry cloth, dampen the cloth in mild detergent, and wipe the panel or case with the damp cloth. Never use solvents such as thinner or benzene, or chemical dust cloths to avoid damaging case or front panel surfaces.

2.5 BASIC OPERATION

The following paragraphs summarize front panel operating controls, give typical test connections, and discuss typical operating examples for the Model 3940.

2.5.1 Front Panel Summary

Figure 2-1 summarizes each front panel feature. For detailed information on each operating feature, refer to Section 3.

2.5.2 Typical Test Connections

Figure 2-2 shows typical test connections between the Model 3940 main synthesizer and a DUT (sub synthesizer connections are essentially the same). Note that 50 Ω characteristic impedance cables such as the Model 7051 should be used for all signal connections.

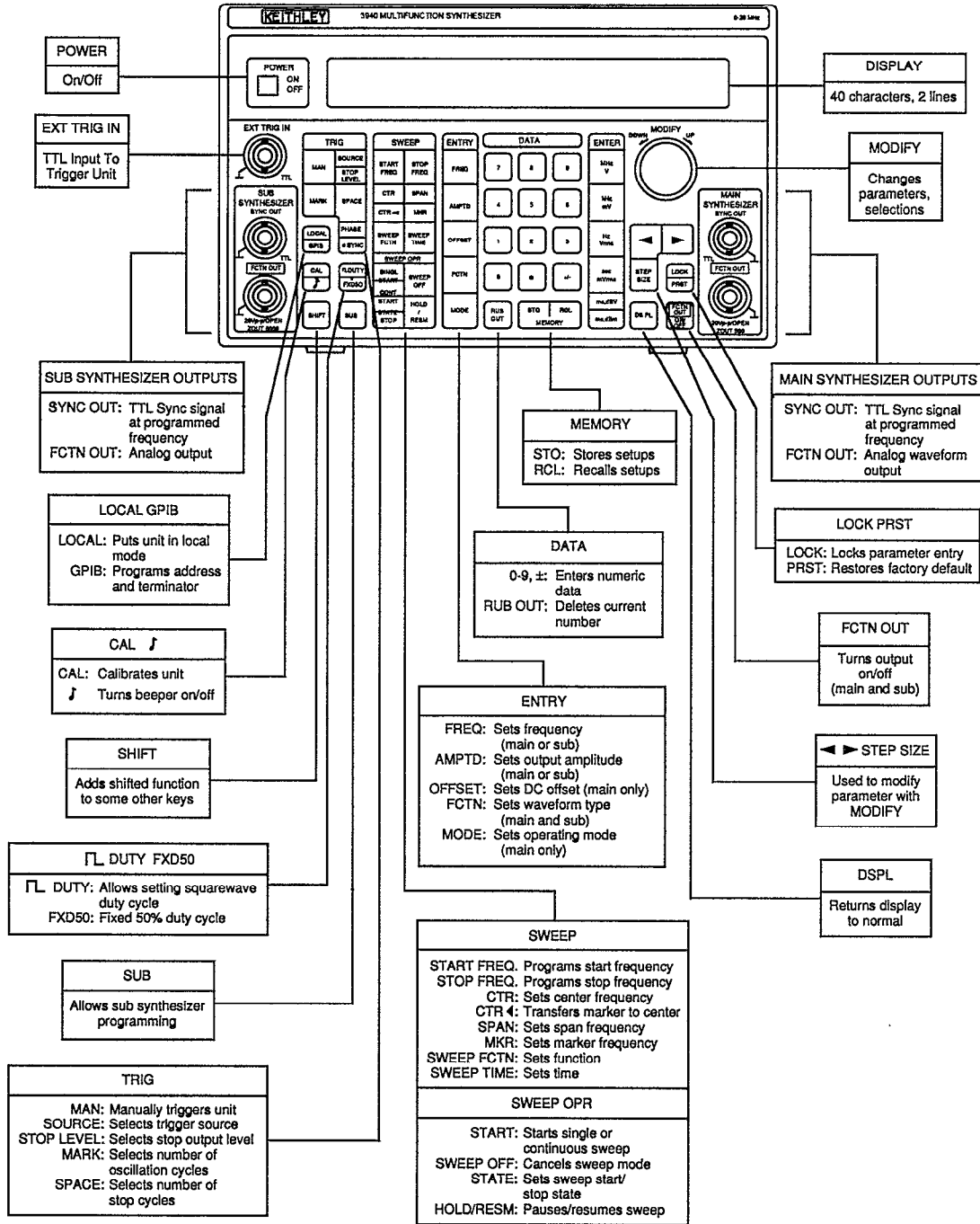
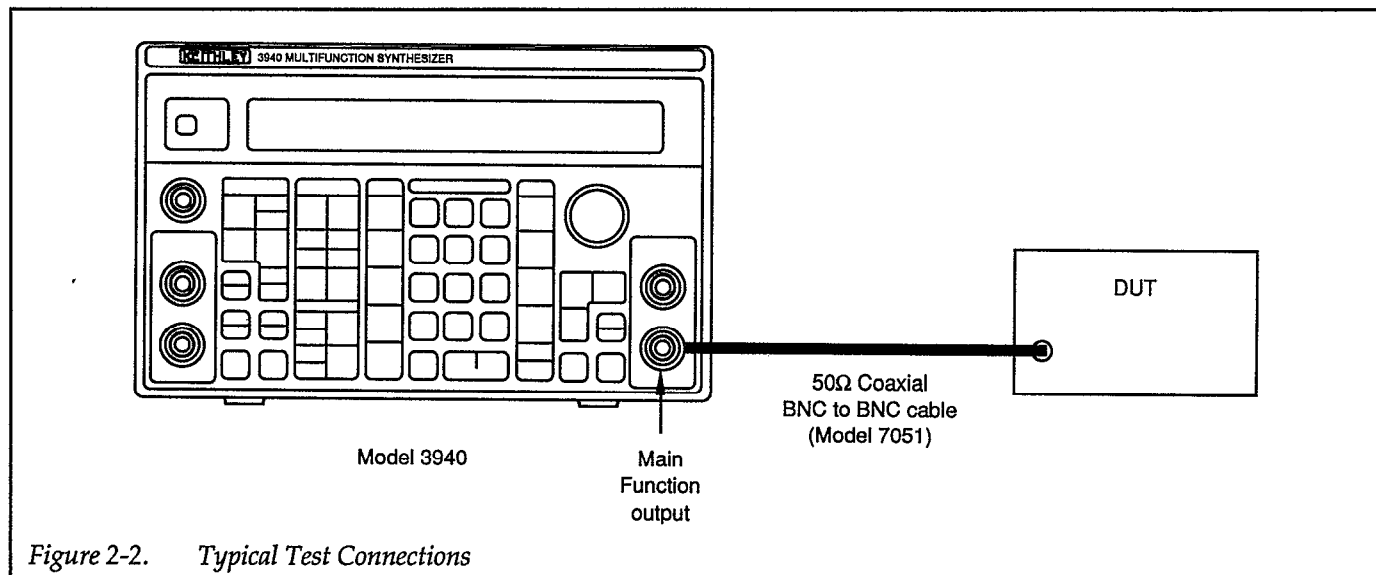

Figure 2-1. Front Panel Summary



2.5.3 Operating Examples

The following examples give step-by-step instructions for setting basic Model 3940 operating parameters. All examples except for Example 7 describe main synthesizer operation. Sub synthesizer operation for frequency, amplitude, and function is similar to main synthesizer operation. Offset, mode, and sweep parameters do not apply to the sub synthesizer.

Example 1: Selecting the Waveform Type (Function)

The waveform type can be selected using the FCTN key as follows:

1. Press FCTN and note that the instrument displays the current function and the available functions.
2. Press the number key corresponding to the desired function (0-6), or rotate the MODIFY knob until the desired function number is displayed. For example, press 3 to choose select the square wave function. The waveform will immediately change to the selected function.
3. Press DSPL to return to the normal display mode.

Example 2: Setting the Waveform Frequency or Period

Use FREQ to set the frequency or period of the output waveform as follows:

1. Press FREQ to enter the frequency programming mode. The instrument will display the allowable frequency range for the selected waveform.

2. To directly enter a completely new numeric frequency value, key in the desired number followed by the appropriate units key (Hz, kHz, or MHz). For example, to enter a frequency of 10.1kHz, press: 1 0.1kHz.
3. To simply modify an existing frequency value, place the cursor on the digit to be changed using ◀ or ▶, then use the MODIFY knob to set the digit to the desired value. Repeat as necessary for all digits to be changed. Note that you can press the STEP SIZE key to multiply or divide by 2 or by 10.
4. To display the time period of the waveform frequency, press the sec key. You can then key in a new time period or modify the existing period, if desired.
5. Press Hz, kHz, or MHz to return to frequency display.
6. Press DSPL to return to normal display.

Example 3: Setting the Output Amplitude

Use the AMPTD key to set the output voltage amplitude as follows:

1. Press AMPTD, and note that the instrument displays the current amplitude and allowed amplitude range.
2. To enter a completely new amplitude value in p-p units, key in the numeric value, then press V or mV, as required. For example, to enter a 30mV p-p amplitude, press: 3 0 mV.
3. To simply modify the existing amplitude value, use the cursor keys and the MODIFY knob to set the value as required.
4. Press DSPL to return to normal display.

Example 4: Programming the DC Offset

The OFFSET key allows you to set the DC or average level of the main synthesizer output waveform, as in the following example:

1. Press OFFSET and note that the instrument displays the current offset value and allowed range.
2. Either key in the desired offset, or use the MODIFY knob and cursor keys to change the value.
3. Press DSPL to return to normal display.

Example 5: Selecting the Operating Mode

The Model 3940 main synthesizer can be operated in continuous, burst, trigger, or gate modes. The operating mode can be set with the MODE key as in the following example:

1. Press MODE and note that the instrument displays the current mode and available modes (continuous, burst, trigger, and gate).
2. Press the number of the desired mode (or rotate MODIFY to choose the desired operating mode).
3. Press DSPL to return to normal display.

Example 6: Controlling Sweep Operation

The Model 3940 main synthesizer can be used to sweep across a desired frequency range. The SWEEP keys allow you to program sweep parameters, while the SWEEP OPR keys control sweep operation. Perform the steps below to demonstrate basic sweep operation:

1. Press START FREQ, and key in or use MODIFY to set the sweep start frequency. For example, press 1 kHz to program a 1kHz start frequency.

2. Press STOP FREQ and set the sweep stop frequency as desired. For example, to program a 10kHz stop frequency, press 10 kHz.
3. Press CTR and SPAN to view the center and span frequencies. With 1kHz and 10kHz start and stop frequencies, the center and span frequencies will be 5.5kHz and 9kHz respectively. NOTE: If you change the center or span frequencies, the start and stop frequencies will be automatically changed accordingly.
4. Press SWEEP FCTN, and choose the type of sweep. For example, press 2 to select a linear, ascending sweep type.
5. Press SWEEP TIME, and program the sweep time as required. For example, press 5 sec to program a five-second sweep time.
6. To generate a single sweep, press SINGL START. The unit will generate one sweep based on selected sweep parameters.
7. To generate continuous sweeps, press SHIFT START CONT. The Model 3940 will generate sweeps continuously based on selected sweep parameters.
8. Press SWEEP OFF to stop a sweep.

Example 7: Using the Sub Synthesizer

Sub synthesizer parameters can be programmed in the same way as the equivalent main synthesizer. The steps below demonstrate how to program the sub synthesizer function, frequency, and amplitude.

1. To program the sub synthesizer function, press SUB FCTN, then choose the desired waveform.
2. Program the sub synthesizer frequency by pressing SUB FREQ, then key in or modify the frequency, as required.
3. To set the sub synthesizer output amplitude, press SUB AMPTD, then set the amplitude as needed.
4. Press SUB DSPL to display sub synthesizer parameters.

SECTION 3

Operation

3.1 INTRODUCTION

This section contains detailed information on front panel operation of the Model 3940. For detailed GPIB (IEEE-488 bus) operation, refer to Section 4.

3.2 FRONT PANEL AND REAR PANEL DESCRIPTION

3.2.1 Front Panel Description

The front panel of the Model 3940 is shown in Figure 3-1. The front panel is made up of a two-line, 40-character liquid crystal display and a control panel with a built-in flat keyboard. The liquid crystal display presents information useful for the operation of the Model 3940, such as

the value of each parameter and the range of permissible parameter values.

The keyboard includes a SHIFT key, which gives certain other keys secondary functions. A key which is shaded with the same color as the SHIFT key requires that you press SHIFT first before accessing the function of that particular key.

The keyboard also includes the SUB key, which allows you to control sub synthesizer parameters. Pressing SUB followed by *FREQ*, for example, allows you to set the frequency of the sub synthesizer.

Most settings are maintained in battery backed-up memory. As a result, the Model 3940 automatically assumes the previous settings when the power is first turned on.

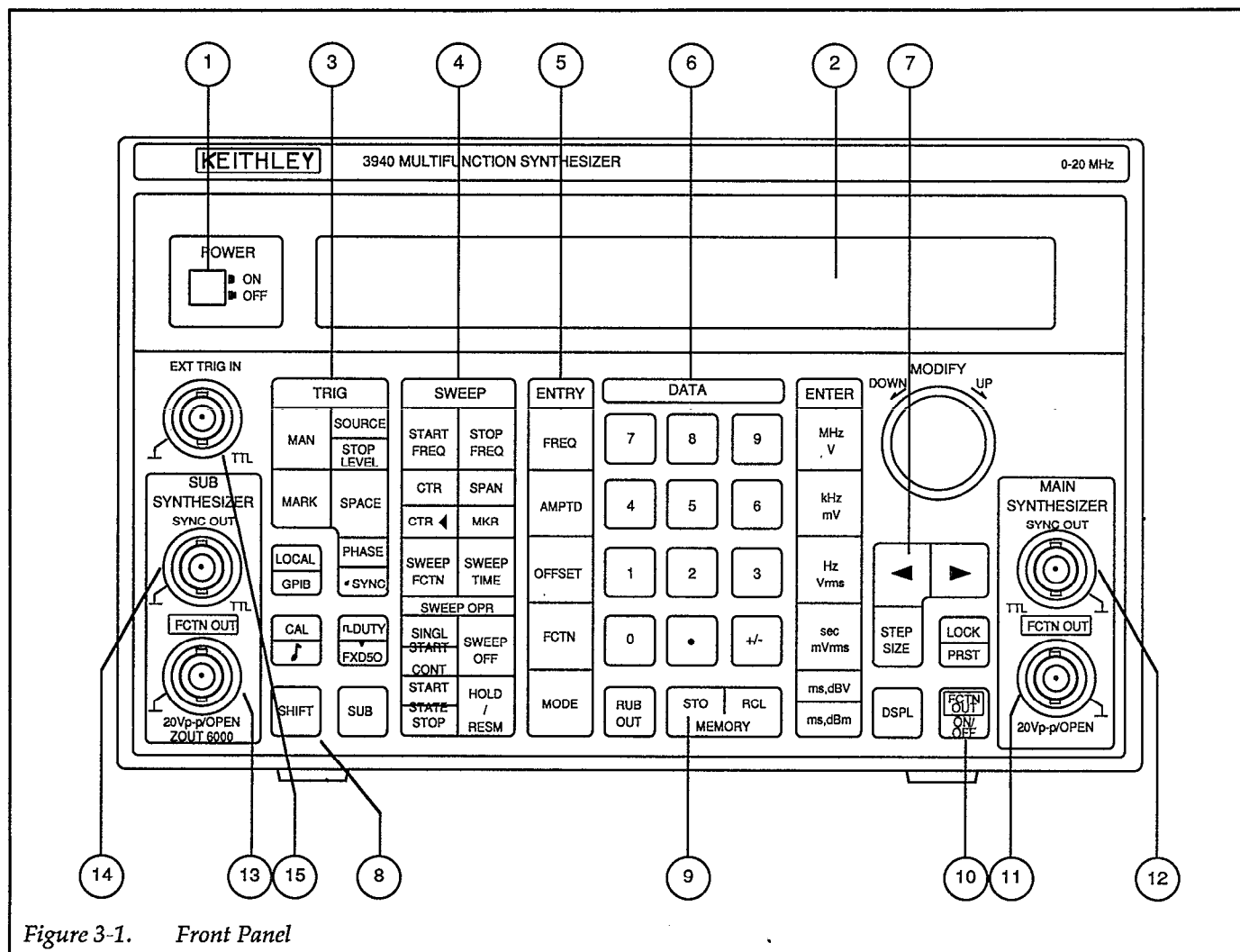

Figure 3-1. Front Panel

Key Representations

This section uses special representation such as [SHIFT], [SUB], [MODIFY], or [SIZE] in the explanation of certain keys. This representation indicates the following:

[SHIFT] Press the applicable key after pressing the SHIFT key to access the shifted key function. The liquid crystal display indicates "SHIFT" in the upper left corner when the Model 3940 is in the shift mode.

[SUB] Press the applicable key after pressing the SUB key to put the Model 3940 in the sub mode, which allows you to set sub synthesizer parameters. The liquid crystal display indicates "SUB" in the upper left corner

when the Model 3940 is in the sub mode.

[MODIFY] Either key in the value using the DATA keys or change a given setting value with the MODIFY knob. The up/down step size when incrementing or decrementing a value is fixed at 1, and the cursor position is also fixed.

[MODIFY] [SIZE] Either key in the value using the DATA keys or change a given setting value with the MODIFY knob. You can specify the digit to be modified by placing the cursor on the desired digit using ◀ or ▶. In addition, you can change the modify up/down increment using the STEP SIZE key.

Detailed Descriptions

Each front panel feature is described below. The circled number to the left of each description corresponds to the appropriate number shown in Figure 3-1.

1 POWER ON/OFF (*Power switch*)

POWER controls AC power to the Model 3940. Press this switch once to turn power on, and press POWER a second time to turn power off.

2 Display

The two-line, 40-character display shows parameter values and other important information during operation. An active display also indicates that instrument power is turned on.

3 TRIG (*Trigger keys for burst, trigger, or gate oscillation*)

The various TRIG keys are used during burst, trigger, or gate oscillation. The trigger mode can be selected using the MODE key described below.

MAN (*Manual trigger*)

Press MAN to manually trigger the unit. In the trigger oscillation mode, the trigger signal is generated each time this key is pressed. In the gate oscillation mode, the gate signal remains on as long as MAN is pressed.

To use only the manual trigger as the trigger signal, select EXT (external) ∇ for the trigger source, and disconnect the cable from the EXT TRIG IN BNC connector.

SOURCE (*Trigger source*)
[MODIFY]

This key allows you to select the trigger source, which includes EXT/INT (external/internal) and ∇ / \blacktriangle (falling edge/rising edge). Selecting EXT will enable front panel triggering through the EXT TRIG IN BNC connector. Selecting INT will enable the internal trigger signal synchronized with the sub synthesizer output. Note that the front panel MAN key is operational for both internal and external trigger sources.

In the gate oscillation mode, ∇ and \blacktriangle correspond to gate on at falling edge and gate on at rising edge, respectively.

STOP LEVEL
[SHIFT], [MODIFY]

The STOP LEVEL key allows you to select the output level during the stop cycle for the burst oscillation, trigger oscillation, and gate oscillation modes (the stop level does not apply to the continuous mode). You can select HOLD or RESET: with HOLD the waveform will stop at the oscillation start phase; with RESET, the waveform will stop at the waveform center value.

When the oscillation mode is set to other than the CONT mode, and the stop level is set to RESET, the upper frequency limit is restricted to 1MHz.

MARK (*Oscillation cycle*)
[MODIFY] [SIZE]

The MARK key allows you to set the number of oscillation cycles for the burst oscillation and trigger oscillation modes.

In the burst oscillation mode, oscillations will be generated for the number of cycles programmed with the MARK key, after which oscillations will be stopped for the number of cycles programmed with the SPACE key (see below). This on-off cycle of oscillations will be repeated continuously.

In the trigger oscillation mode, oscillations will be generated for the programmed number of cycles only when a trigger is applied. The permitted range of mark oscillation cycles is from 0.5 cycle to 32,768 cycles, and the resolution is 0.5 cycle.

SPACE (*Stop cycle*)
[MODIFY] [SIZE]

The SPACE key allows programming of the number of stop cycles for the burst oscillation mode. In the burst oscillation mode, oscillations will be generated for the number of cycles set with the MARK key, and the off or stop period will occur for the number of cycles set with the SPACE key. This on-off cycle of oscillations will be repeated continuously.

The permissible range of settings is from 0.5 cycle to 32,768 cycles with 0.5 cycle resolution.

PHASE (*Start/stop phase*)
[MODIFY] [SIZE]

The PHASE key allows programming of the start/stop phase setting for the burst or gate oscillation modes. The allowed phase range is from -360.0° to 360.0° .

This phase parameter can also be used as a resume phase for oscillation when using phase sync.

(SUB) PHASE (*Sub Synthesizer Phase*)
[SUB], [MODIFY] [SIZE]

Pressing [SUB] PHASE allows you to set the phase of the sub synthesizer output signal. The allowed phase range is from -360.0° to 360.0° . The synthesizer phase can also be used to synchronize phases with the sub synthesizer when using phase sync.

ϕ SYNC (*Phase sync*)
[SHIFT]

The ϕ SYNC key is used for the phase sync mode.

When using the main synthesizer and the sub synthesizer for phase sync, oscillation will synchronize phases when this key is pressed, or when the GPIB "SYN" command is given.

When a multiphase oscillator is formed by connecting two Model 3940s together with an optional Model 3949 Synchronous Cable, master unit and slave unit oscillation will both enter the resume phase when the master unit ϕ SYNC key is pressed, or when the GPIB "SYN" command is sent to the master unit. Pressing the slave unit ϕ SYNC key or sending the GPIB "SYN" command to the slave unit are considered to be invalid operations.

4 SWEEP (*Frequency sweep keys*)

The various SWEEP keys are used to program sweep functions such as start and stop frequency, center and span frequencies, and sweep function and sweep time. The paragraphs below summarize the operation of these keys. Refer to the specifications located in Appendix B for details on the sweep range.

Note that frequency parameters can also be set using waveform period. See the discussion on the

ENTRY keys **5** for information on frequency and period setting.

START FREQ (*Start frequency*)
[MODIFY] [SIZE]

The START FREQ key allows you to set the start frequency of the frequency sweep. You can specify a start frequency that is either higher or lower than the stop frequency. The relationship between the start and stop frequency values determines the sweep direction. If the start frequency is higher than the stop frequency, the sweep will be performed in a descending direction. If the start frequency is lower than the stop frequency, the sweep will be performed in the ascending direction.

If the start frequency is changed, the sweep range will be determined by the new start frequency and the current stop frequency.

STOP FREQ (*Stop frequency*)
[MODIFY] [SIZE]

The STOP FREQ key allows you to set the stop frequency of the frequency sweep. You can specify a stop frequency that is either higher or lower than the start frequency. If the stop frequency is higher than the start frequency, the sweep will be performed in ascending order. If the stop frequency is lower than the start frequency, the sweep will be performed in descending order.

If the stop frequency is changed, the sweep range will be determined by the new stop frequency and the current start frequency.

CTR (*Center frequency*)
[MODIFY] [SIZE]

The CTR key allows setting of the center frequency of the frequency sweep. The center frequency is specified as the center frequency for the linear scale, and is not the sweep time basis center frequency for LOG sweep.

The relationship between the current start and stop frequency values determines the sweep direction. If the center frequency is changed, the start and stop frequencies will be changed, but the span frequency will remain constant.

CTR ◀ (*Substitute of marker frequency for center frequency*)
[SHIFT]

The CTR ◀ key substitutes the marker frequency for the center frequency. The sweep direction and span frequency are affected in the same manner as when using the center frequency setting. If the substituted marker frequency is different than the center frequency, the start and stop frequencies will change accordingly.

SPAN (*Frequency span*)
[MODIFY] [SIZE]

This key allows you to set the frequency span of the frequency sweep. The relationship between the start and stop frequency values determines the sweep direction. If the frequency span is changed, the start and stop frequencies will be changed so that the sweep range is determined by the new frequency span and the current center frequency, which will not change.

MKR (*Marker frequency*)
[SHIFT], [MODIFY] [SIZE]

This key allows you to set the marker frequency of the frequency sweep. Note that you can specify only one marker frequency. While the oscillation frequency is higher than the programmed marker frequency during a sweep, the marker output signal available at the rear panel MKR OUT jack will be set low. The marker output signal at MKR OUT will be set high at all other times.

SWEEP FCTN (*Sweep function*)
[MODIFY]

The SWEEP FCTN key allows you to select the sweep function. Available sweep functions include: step (\square), linear triangular wave and sawtooth wave (\wedge or \vee), and log triangular wave or sawtooth wave (\wedge or \vee).

With the step sweep function, the output frequency simply changes between the start frequency and stop frequency at intervals determined by the sweep time. With the linear and log functions, the frequency increases or decreases linearly or logarithmically, respectively.

SWEEP TIME (*Sweep time*)
[MODIFY] [SIZE]

The SWEEP TIME key allows you to set the sweep time, which is the time period from the start frequency to the stop frequency. The allowed sweep time range is from 5msec to 9,999sec.

SWEEP OPR (*Sweep Operation*)

SINGL START (*Single start: single-sweep start*)

This key starts a single sweep. Only one sweep per key press will be generated.

CONT START (*Continuous start: repeated sweep start*)
[SHIFT]

This key starts repeated sweeps, which will be generated continuously until halted with the HOLD or SWEEP OFF keys.

SWEEP OFF (*Sweep off*)

SWEEP OFF cancels the sweep mode. The oscillation frequency will remain at the current frequency when this key is pressed, and the MKR OUT, SWEEP SYNC OUT, and X DRIVE OUT signals on the rear panel are set to high level, high level, and 0V, respectively.

START STATE (*Start state: start frequency output*)

This key resets the sweep and sets the output frequency to the start frequency.

When START STATE is pressed, the MKR OUT and SWEEP SYNC OUT signals on the rear panel are set high. The X DRIVE OUT signal is set to 0V when the start frequency is lower than the stop frequency; the X DRIVE OUT signal is set to 10V when the start frequency is higher than the stop frequency. These signals can be used for scale adjustments of XY recorders.

STOP STATE (*Stop frequency output*)
[SHIFT]

STOP STATE performs the opposite function of the START STATE key in that it sets the output frequency to the stop frequency.

When STOP STATE is pressed, the MKR OUT and SWEEP SYNC OUT signals on the rear panel are set high. The X DRIVE OUT signal is set to 0V when the start frequency is higher than the stop frequency; it is set to 10V when the start frequency is lower than the stop frequency.

HOLD/RESM (*Hold/resume: temporary stop and resume*)

This key alternately stops and resumes the sweep.

Pressing HOLD/RESM while sweep is in progress will halt the sweep with the frequency, MKR OUT, SWEEP SYNC OUT, and X DRIVE OUT signals present at that time maintained at their present values. Pressing HOLD/RESM with the sweep halted resumes the sweep from the existing conditions.

5 ENTRY (*Main parameter setting keys*)

FREQ (Frequency)
[MODIFY] [SIZE]

The FREQ key allows you to set the output frequency of the main synthesizer. The allowed frequency range will vary according to the waveform type, oscillation mode, stop level, and waveform duty cycle (see the specifications in Appendix B for details).

In many cases, the instrument will allow you to set the waveform frequency to a higher value than the guaranteed specification range. However, the quality of the waveform will deteriorate if you set the frequency above the range of guaranteed specifications for those particular waveform conditions. In all cases, however, an absolute upper maximum setting limit of 1MHz, 10MHz, or 25MHz will apply, depending on waveform settings.

The oscillation frequency can be programmed in frequency units or time period units. The upper limit frequency for period-based setting of the permissible range is as follows:

Upper Frequency: 25MHz
Limits of Period-based Setting Range: 0.040µsec to 10,000.0sec

Upper Frequency: 10MHz
Limits of Period-based Setting Range: 0.100µsec to 10,000.0sec

Upper Frequency: 1MHz
Limits of Period-based Setting Range: 1.000µsec to 10,000.0sec

For period-based settings, the frequency is set to the value of the reciprocal that is rounded to the nearest number below 0.1mHz. Therefore, period-based setting will cause significant errors when the number of digits for the value of the reciprocal that is rounded is small. For example, values of either 6,666.67sec or 4,000.01sec will result in a frequency of 0.0002Hz.

If you press FREQ during sweep operation or during sweep hold, the current frequency will be displayed, but you will not be able to change the frequency.

The phase of the waveform will be continuous even when the frequency is changed.

(SUB) FREQ (*Sub synthesizer frequency*)
[SUB], [MODIFY] [SIZE]

Pressing [SUB] FREQ accesses sub synthesizer frequency setting. The allowed sub synthesizer frequency range is from 0Hz to 100kHz, and the allowed frequency range is constant regardless of waveform type or other parameters.

As with the main synthesizer, the sub synthesizer frequency can be set in either frequency or time period units. The permitted range of time period units is from 10.000µsec to 10,000.0sec. For period-based setting, the frequency is set to the value of the reciprocal that is rounded to the nearest number below 0.1mHz. Therefore, period-based setting will cause significant errors when the number of digits for the value of the reciprocal that is rounded is small. For example, values of either 4,000.00sec or 2,857.15sec will result in a frequency of 0.0003Hz.

The phase of the output waveform will be continuous even when the frequency is changed.

AMPTD (*Amplitude*)
[MODIFY] [SIZE]

Pressing AMPTD allows you to set the output amplitude of the unit. The allowed amplitude ranges from 2.00mV p-p/no load to 20.0V p-p/no load when the DC offset is 0V. In other cases, the upper and lower limits are restricted to the range specified in Table B-4 (Appendix B). The values for the amplitude setting are for no-load output conditions. The unit can be set to display either the no-load or 50Ω amplitude value (see below).

The amplitude setting can be specified using either p-p, rms, dBV, or dBm units. (Note, however, that dBm units can be used only when a 50 Ω load is specified). You can specify the appropriate units by pressing the appropriate ENTER units key when entering the amplitude. Use mV or V for p-p values, mVrms or Vrms for rms values, or dBm or dBVB for dB values.

Note that p-p values are the only permissible units for DC or arbitrary waveforms, and that the p-p value varies from one waveform to another if you specify the amplitude as an rms or dBV value. Also note that the amplitude set by the AMPTD key is the amplitude of an AC waveform. Set the amplitude of a DC waveform type with the OFFSET key.

(AMPTD) (*Amplitude display selector*)
[SHIFT]

Pressing SHIFT AMPTD toggles the unit between displaying the no-load amplitude and the 50 Ω amplitude while setting the main synthesizer amplitude. Each time this key sequence is performed, the display will toggle between no-load and 50 Ω amplitude values.

Since the output impedance of the Model 3940 is 50 Ω , the amplitude display with 50 Ω loads (with identical outputs) will correspond to half of the no-load display value (-6dB).

(SUB) AMPTD (*Sub synthesizer amplitude*)
[SUB], [MODIFY] [SIZE]

Pressing SUB AMPTD allows you to set the sub synthesizer output amplitude.

The allowed sub synthesizer amplitude ranges from 0.2V p-p/no load to 20.0V p-p/no load. The sub synthesizer amplitude setting value is the no-load value (50 Ω display values are not available with the sub synthesizer).

Amplitude values can be entered using p-p, rms, or dBV units. Use V or mV for p-p units, Vrms or mVrms for rms units, and, of course, dBV for dBV units. Note that the p-p value may vary depending on the waveform when using rms and dBV amplitude units.

OFFSET (*DC offset*)
[MODIFY] [SIZE]





The OFFSET key enables DC offset voltage programming. The allowed offset is between -10V/no load and 10V/no load for a DC waveform. For other waveform types, the offset range is restricted to the values specified in Table B-4 (Appendix B). All specified offset ranges are for no-load conditions.

(OFFSET) (*DC offset display selector*)
[SHIFT]

Pressing SHIFT OFFSET toggles the offset display units between the no-load value and the 50 Ω value. Each time this key is pressed, the offset value display will toggle to the opposite type.





Since the output impedance of the Model 3940 is 50 Ω , the 50 Ω DC offset display will correspond to half of the no load display value for identical outputs.

FCTN (*Function: waveform*)
[MODIFY]

This key allows you to choose the output waveform of the main synthesizer. Available waveforms include: DC, SIN (sine wave),  (triangular wave),  (square wave),  (ascending sawtooth wave),  (descending sawtooth wave), and ARB (arbitrary wave programmed over the GPIB).

If the waveform setting is DC or ARB, only p-p amplitude values can be set.

(SUB) FCTN (*Sub Synthesizer Function: Sub synthesizer waveform*)
[SUB], [MODIFY]

Pressing SUB FCTN accesses sub synthesizer waveform programming. Available sub synthesizer waveforms include: SIN (sine wave),  (triangular wave),  (square wave),  (ascending sawtooth wave),  (descending sawtooth wave).

If the waveform setting is changed, the amplitude setting value is changed automatically to the p-p value, and the new waveform is output with the same p-p amplitude.

MODE (*Oscillation mode*)
[MODIFY]

The MODE key programs the oscillation mode setting. Available oscillation modes include: CONT (continuous oscillation), BRST (burst oscillation), TRIG (trigger oscillation), and GATE (gate oscillation).

6 DATA (*Numeric keys for parameter entry*)

The DATA key set consists of numeric keys for entering a value and ENTER (units) keys for setting the units of the entered value. The "." (decimal point) key and the +/- (sign inversion) key do not affect parameters for which they have no function.

Parameters that are selected with one numeric character, such as waveform and oscillation mode, do not require that any ENTER key be pressed. Such parameters are set simply by entering one numeric character (or by rotating the MODIFY knob as required).

For other parameters, enter the required value with the numeric keys, then press the appropriate ENTER units key. If you enter the incorrect value, press the RUB OUT (delete) key. RUB OUT deletes the numeric character or decimal point from the rightmost position. To delete the entire entered value and return the display to the current value, press the original function key to enable parameter entry for that function.

Pressing any of the ENTER keys will enter the values for the MARK and SPACE waveform cycles and phase parameters where only one type of unit is used, or for the GPIB address in which case parameters contain no units.

For frequency and amplitude where parameters can be entered in different types of units, select the appropriate units key from the ENTER key to complete entry of the value.

The units keys also have a units conversion function. This feature is available for unit conversions such as frequency-to-period conversion for frequency, as well as amplitude p-p/rms/dBV/dBm conversions. When the units key of the unit to be changed is pressed with the current setting displayed, the display will be changed to reflect the newly selected units; note, however, that the actual output remains unchanged.

7 MODIFY (*Modify operation knob*)

In addition to using the numeric keys, you can set any parameter except the GPIB address, delimiter, and memory number by using the MODIFY knob. The MODIFY knob is operational when the Model 3940 is in the appropriate parameter-entry mode, and the unit displays the current parameter value.

MODIFY (*Modify knob*)

When the step size is ± 1 , you can select the digit to increase or decrease by 1 by placing the cursor under the appropriate digit (use ◀ or ▶) and turning the MODIFY knob to the right or left.

When the step size is $\times +2$, you can divide the selected parameter by 2 by turning knob counter-clockwise, or multiply the parameter by 2 by turning the knob clockwise. Similarly, when the step size is $\times +10$, you can divide or multiply the parameter by 10 by rotating the knob counter-clockwise or clockwise respectively. Note that the cursor will not be displayed when the step size is $\times +2$ or $\times +10$.

◀ (*Left cursor*)

This key moves the cursor to the left by one digit each time it is pressed, and it will automatically repeat left cursor movement as long as it is held down.

▶ (*Right cursor*)

This key moves the cursor to the right by one digit each time it is pressed, and it will automatically repeat right cursor movement as long as it is held down.

STEP SIZE (*UP/DOWN step size*)

STEP SIZE changes the MODIFY knob UP/DOWN step size. For parameters with values that can be changed using variable step sizes, the step size will change in the following order each time this key is pressed: ± 1 $\times +2$ $\times +10$...

8 Miscellaneous Keys

1 — LOCAL (*Return to local*)

LOCAL cancels remote and returns the instrument to the local mode when used over the GPIB.

GPIB (*GPIB Address: GPIB address, delimiter*)
[SHIFT]

The GPIB key allows you to program the GPIB primary address and the output delimiter used when the Model 3940 is acting as a GPIB talker. Only the numeric keys can be used for setting these parameters (the MODIFY knob cannot be used). The allowed range for the primary address is from 0 to 30, and the delimiter can be selected for CR/LF or CR (CR and LF or CR only).

The GPIB primary address is the integer part of this parameter, and the delimiter is defined by the fractional part. For example, a parameter of 2.0 indicates a primary address of 2 and defines CR/LF as the delimiter. Similarly, a parameter of 4.1 indicates a primary address of 4 with CR as the delimiter.

To change only the primary address, enter only the integer part of the number; the delimiter will remain unchanged. To change only the delimiter, enter the decimal point followed by the fraction (0 or 1); the primary address value will remain unchanged.

When programming the primary address and/or delimiter, remember that you must press any one of the ENTER keys to complete the entry process.

CAL (*Calibration: Main synthesizer output calibration*)

CAL performs front panel calibration, which corrects main synthesizer AC amplitude and offset errors. Calibration takes slightly more than 10 seconds to complete.

During the calibration procedure, the front panel display will indicate that calibration is in progress (the number of asterisks displayed will decrease as calibration progresses). The main synthesizer FCTN OUT signal will be turned off, and the main synthesizer SYNC OUT signal will be unsynchronized while calibration is being performed.

To cancel calibration while the procedure is in progress, press the CAL key a second time. To cancel calibration operations over the GPIB, send the "CAB" command. Other key operations and GPIB commands will not be recognized during calibration operations (except for GPIB inquiry commands which will be recognized).

♯ (*Beep sound*)
[SHIFT], [MODIFY]

This key controls the beep that sounds when you press front panel keys and when errors occur. You can turn the beep OFF (0) or ON (1).

□ **DUTY** (*Square-wave duty cycle*)
[MODIFY] [SIZE]

The □ DUTY key allows you to program the square-wave duty cycle. The allowed duty cycle ranges from 5.0% to 95.0%.

Two duty-cycle modes are available: 50% fixed and variable. In the variable mode, the upper frequency limit is restricted to 1MHz even if the duty cycle is set at 50%.

FXD50 (*Fixed 50% duty cycle*)
[SHIFT]

This key fixes the square-wave duty cycle at 50%.

SHIFT

The SHIFT key adds a secondary function to many other front panel keys. Those keys that have shifted functions have those functions represented on the lower part of each key using the same color as the SHIFT key. Keys with shifted functions include STOP LEVEL, MKR, GPIB, and FXD50.

The SHIFT key is also used to choose between no-load and 50Ω display modes for the main synthesizer amplitude and offset settings. See descriptions under **5** for more details.

When the SHIFT key is first pressed, the unit enters the shift mode, and the liquid crystal display indicates "SHIFT" in the upper left corner. The shift mode is canceled when any key including the SHIFT key is pressed (if a key with a shift function is pressed, the unit enters that mode; otherwise, it returns to the mode it was in before SHIFT was pressed).

SUB (*Sub synthesizer mode*)

The SUB key allows access to the following sub synthesizer parameter settings: FREQ, AMPD, FCTN, and PHASE. In order to program any of these four sub synthesizer parameters, press the SUB key followed by appropriate key. When the

instrument enters the sub synthesizer mode, the liquid crystal display indicates "SUB" in the upper left corner. The sub mode is cancelled when any key except for the four sub synthesizer keys outlined above is pressed.

The main parameters of the sub synthesizer can be displayed by pressing SUB DSPL.

9 MEMORY (Memory operation keys)

The MEMORY keys allow you to store and recall instrument setups. Ten units of memory, numbered 0 through 9, are available for setup storage.

STO (Store: store setup in memory)

The STO key stores the current instrument setup parameters in the selected memory location (0-9). You can use only numeric keys to store setups (the MODIFY knob cannot be used). Pressing the numeric key will immediately store the current parameter values and erase the previous setup in the selected memory location.

RCL (Recall: read setup from memory)

RCL reads instrument setups from the desired memory location (0-9). You can use only numeric keys for selecting memory locations to recall (the MODIFY knob cannot be used). Pressing the numeric key will immediately read the contents of the selected memory location and will change the current instrument settings accordingly.

10 Additional Keys and Connectors

LOCK (Lock out front panel keys)

This key allows you to disable most front panel keys. Available modes are ON (1) and OFF (0). When the lock is ON, most front panel keys are disabled, and the corresponding operating modes cannot be changed. However, both LOCK and FCTN OUT ON/OFF are still operational when the lock is ON. In addition, trigger input and sweep control input from appropriate BNC connectors are also enabled.

Lock ON/OFF can also be programmed over the GPIB with the "LCK" command, and GPIB programming is not disabled when the lock is on. You can return the unit to local with the LOCAL key

even when the lock is ON. However, you cannot return the instrument to local with the LOCAL key when the GPIB LLO (Local Lockout) command is in effect.

Current parameter values such as frequency can be displayed by pressing appropriate keys when the lock is ON. The liquid crystal display will indicate "LOCK" in the position where the modification step size is normally indicated. Also, parameter names will not flash, and the cursor will not be displayed.

PRST (Preset) [SHIFT]

The PRST key recalls the factory default preset operating parameters. Refer to the specifications in Appendix B for a summary of preset parameter settings.

DSPL (Display: Main synthesizer main parameter display)

DSPL displays the following main synthesizer main parameters simultaneously: Signal output ON/OFF (blank for ON), frequency, amplitude, DC offset, waveform, oscillation mode, and sweep mode (blank for normal oscillation). Note that parameters cannot be programmed from the main parameter display; you must press the appropriate keys before setting parameters.

(SUB) DSPL (Sub Synthesizer Display: Sub synthesizer main parameter display) [SUB]

Pressing SUB DSPL displays the following sub synthesizer main parameters simultaneously: Signal output ON/OFF (blank for ON), frequency, amplitude, waveform, and phase. Sub synthesizer parameters cannot be programmed from the sub synthesizer main parameter display.

FCTN OUT ON/OFF (Signal output ON/OFF)

FCTN OUT turns both the main and sub synthesizer outputs off or on simultaneously. Each time this key is pressed, ON/OFF will toggle to the opposite state.

When FCTN OUT is OFF, the main synthesizer FCTN OUT signal will be open-circuited, and the sub synthesizer FCTN OUT signal will be set to 0V. In addition, the main synthesizer SYNC OUT

signal will be identical to the output during FCTN OUT ON, but the sub synthesizer SYNC OUT signal will be set to high or low logic levels.

The liquid crystal display will indicate "OFF" in the upper left corner when the Model 3940 is in the FCTN OUT OFF mode (except in the SHIFT, SUB or REMOTE modes).

Note that the factory default setting for FCTN OUT is ON at power on.

11 MAIN SYNTHESIZER FCTN OUT (*Main synthesizer waveform output*)

This BNC jack provides the main synthesizer waveform output signal. The maximum output voltage range is $\pm 10\text{V}$ /no load, and the output impedance is 50Ω .

12 MAIN SYNTHESIZER SYNC OUT (*Main synthesizer synchronous output*)

This BNC jack provides a TTL-level square wave signal at the same frequency as the main synthesizer function output waveform. The output impedance is approximately 50Ω , and it can be used with 50Ω terminations.

13 SUB SYNTHESIZER FCTN OUT (*Sub synthesizer waveform output*)

This BNC jack provides the sub synthesizer waveform output signal. The maximum output voltage range is $\pm 10\text{V}$ /no load, and the output impedance is 600Ω .

14 SUB SYNTHESIZER SYNC OUT (*Sub synthesizer synchronous output*)

This BNC jack is the sub synthesizer synchronous output, which outputs a TTL-level square wave signal at the sub synthesizer output frequency.

15 EXT TRIG IN (*External-trigger input*)

This BNC connector is an input for external TTL-level signals, which can be used to trigger the Model 3940.

EXT TRIG IN is internally pulled up to a high logic level, which means that the external trigger input will remain high with no input signal connected. If the EXT  trigger source is selected with the unit in the gate oscillation mode, the gate signal will be enabled, and the unit will effectively be in the continuous oscillation mode with no external trigger input signal applied.

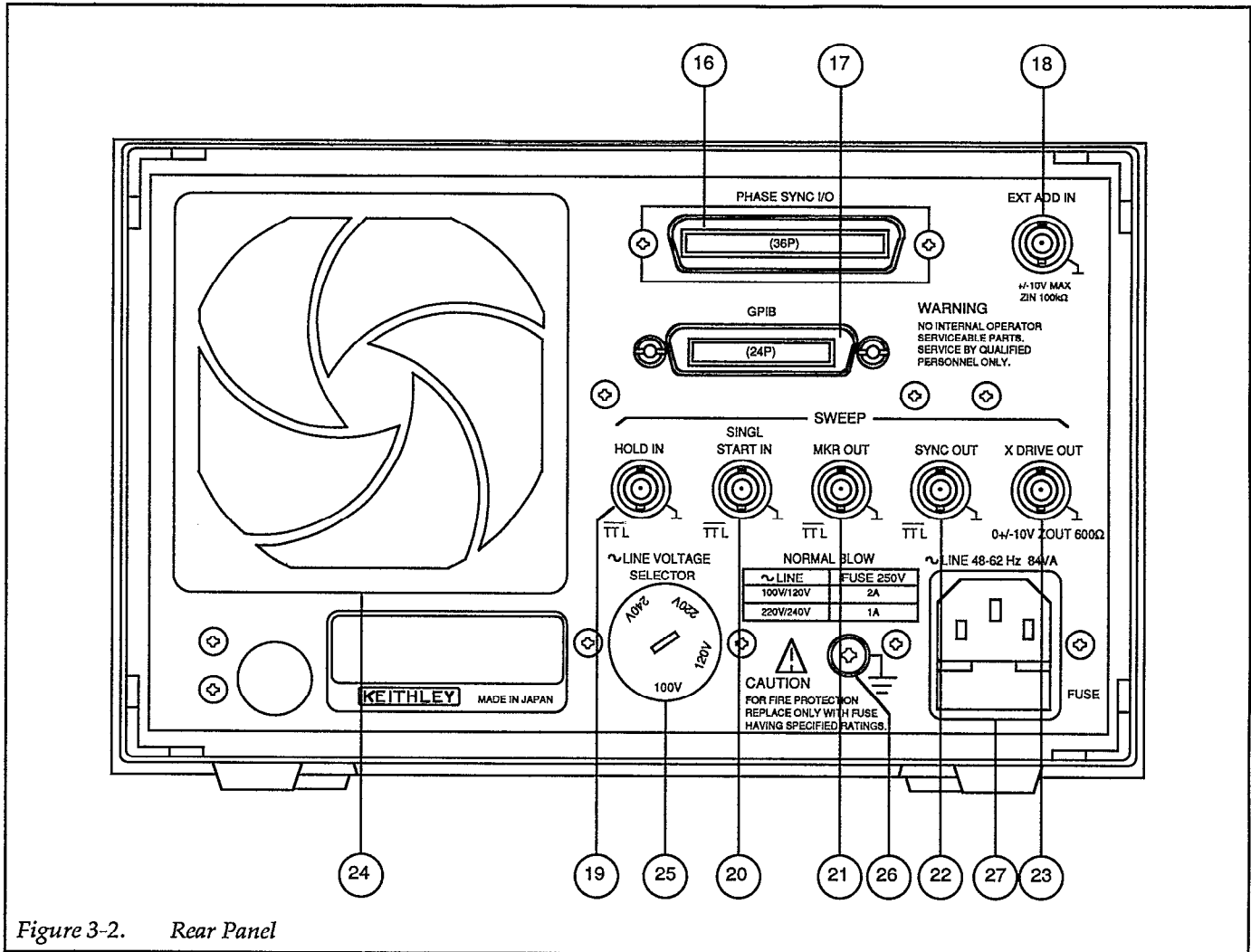

Figure 3-2. Rear Panel

3.2.2 Rear Panel Description

The following paragraphs describe the various aspects of the Model 3940 rear panel, which is shown in Figure 3-2.

16 PHASE SYNC I/O (*Synchronous operation input/output*)

PHASE SYNC I/O is a 36-pin connector used to connect two Model 3940s together to form a multi-phase oscillator. The optional Model 3949 Synchronous Cable is required to make connections.

17 GPIB (*General Purpose Interface Bus connector*)

This connector is the 24-pin connector used to connect the Model 3940 to the GPIB (IEEE-488 bus). Shielded GPIB cables, such as the Model 7007, are recommended for bus connections.

18 EXT ADD IN (*External add input*)

This BNC connector is designed for applying external waveforms. The input impedance is approximately 100kΩ. Signals applied to this input will be added to the main synthesizer waveform and subsequently output. See the specifications in Appendix B for more details on the external add input.

19 (SWEEP) HOLD IN (*Sweep hold input*)

This BNC connector accepts a TTL-level signal used for sweep hold input. The sweep is halted as long as the input signal is at a low logic level.

20 (SWEEP) SINGL START IN (*Single-sweep start input*)

This BNC connector accepts a TTL-level signal used to start a single sweep. A single sweep starts at the falling edge of the input signal.

21 (SWEEP) MKR OUT (*Sweep marker output*)

This BNC connector provides a TTL-level signal used for sweep marker output. This signal goes low when the frequency rises above the marker frequency during a sweep, and it remains high at all other times.

22 (SWEEP) SYNC OUT (*Sweep synchronous output*)

This BNC connector provides a TTL-level signal for sweep synchronous output. This signal is at low level while a sweep from the start frequency to the stop frequency is in progress; it is at a high level at all other times.

23 (SWEEP) XDRIVE OUT (*Sweep X-axis drive output*)

This BNC connector provides the signal for sweep X-axis drive output. The output voltage ranges from 0V to 10V, and it increases and decreases according to the sweep direction as the sweep is generated. This output signal is intended for use as the X-axis drive for an oscilloscope or XY recorder.

24 Air intake port

An air intake port is provided on the rear panel for cooling. Allow at least four inches of clearance behind the port when installing against a wall.

When the air filter becomes dirty, remove it by pulling the air filter cover, and clean the filter with pressurized air or wash it with a mild detergent. Make sure that the filter is completely dry before installing it back in the unit. The filter should be

cleaned at least once every three months in a clean environment, or at least once a month in a dirty environment.

CAUTION

Immediately turn off the power to the unit if the fan ceases to operate. Be careful not to obstruct the exhaust ports on the upper and lower panels. Failure to observe these precautions may result in instrument damage.

25 LINE VOLTAGE SELECTOR (*Supply voltage switch*)

This switch sets the Model 3940 for the correct line voltage. Using a flat-blade screwdriver, set the switch in the proper position for the supply voltage in your area.

WARNING

Disconnect the line cord before changing setting the switch position.

CAUTION

Operation the Model 3940 on an incorrect line voltage may result in instrument damage.

26  (Grounding terminal)

The grounding terminal is connected to the chassis of the Model 3940. To prevent interference and for safety, be sure to ground this terminal.

WARNING

If the Model 3940 is connected to an ungrounded AC outlet, connect the grounding terminal to safety earth ground using #18AWG minimum wire before use.

27 LINE (*Power input connector*), FUSE

The LINE connector is used to connect the instrument to AC power.

WARNING

To avoid the possibility of electric shock, connect the Model 3940 to a grounded AC outlet.

The fuse holder is located below the LINE connector. The fuse can be replaced by disconnecting the line cord and prying out the fuse holder. Replace only with the type indicated below.

Line Voltage	Fuse Current Rating
110V, 120V	2A
220V, 240V	1A

NOTE: fuses are 5 × 20mm and have 250V, normal blow ratings.

3.3 Input and Output Connections

3.3.1 Input Connections

Four signals are applied to the BNC connectors of the Model 3940. The specifications of the input signals are given below.

CAUTION

Be careful not to exceed the maximum allowable input voltages, or instrument damage may occur.

Logic Inputs

Logic inputs include EXT TRIG IN (external trigger input), SWEEP SINGL START IN (single-sweep start input), and SWEEP HOLD IN (sweep hold input). Key specifications for these inputs include:

Input voltage: TTL level
 Allowable maximum input voltage: 0V to +5V
 Circuit: See Figure 3-3, Logic Input Circuits.

Analog Input

The EXT ADD INPUT jack can be used to apply an external analog signal which is then added to the main synthe-

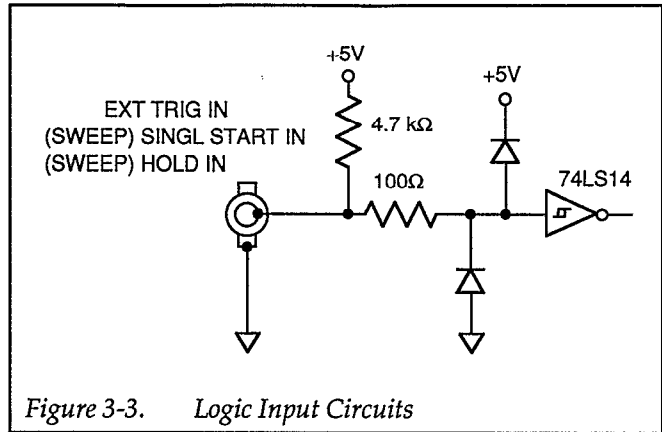

Figure 3-3. Logic Input Circuits

sizer output signal. Important specifications are summarized below.

Input voltage range: Max. ±10V (variable according to AC amplitude, DC offset, and waveform settings)

Allowable maximum input voltage: ±15V

Input frequency range: DC to 1MHz

Input impedance: Approximately 100kΩ (101kΩ)

Circuit: See Figure 3-4, Analog Input Circuit

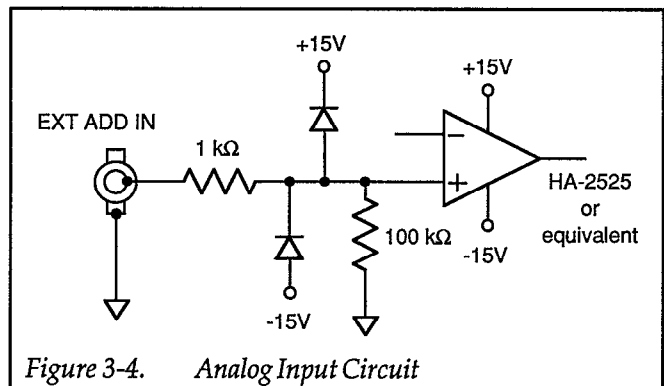

Figure 3-4. Analog Input Circuit

3.3.2 Output Connections

Six output signals are available from various BNC connectors of the Model 3940. The specifications for the output signals are given below.

CAUTION

Be careful not to connect an external signal to an output connector, or instrument damage may occur.

Logic Outputs

Logic outputs include the MAIN SYNTHESIZER SYNC OUT (main synthesizer synchronous output), SUB SYNTHESIZER SYNC OUT, sub synthesizer synchronous output), SWEEP MKR OUT, (sweep marker output), and SWEEP SYNC OUT (sweep synchronous output. Specifications for these outputs are summarized below.

Output voltage: TTL level
Circuits: See Figure 3-5, Figure 3-6, and Figure 3-7

Analog Outputs

MAIN SYNTHESIZER FCTN OUT

(Main Synthesizer Waveform Output)
Maximum output voltage: $\pm 10V$ /no load, $\pm 5V$ /50 Ω load
Output impedance: 50 Ω
Recommended load impedance: 50 Ω or more

SUB SYNTHESIZER FCTN OUT

(Sub Synthesizer Waveform Output)
Maximum output voltage: $\pm 10V$ /no load
Output impedance: 600 Ω
Recommended load impedance: 10k Ω or more

SWEEP X DRIVE OUT

(Sweep X Axis Drive Output)
Output voltage: 0V to +10V/no load
Output impedance: 600 Ω
Recommended load impedance: 10k Ω or more

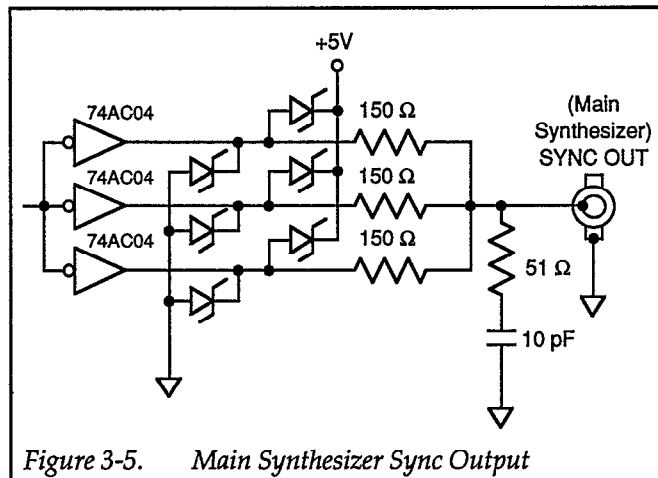

Figure 3-5. Main Synthesizer Sync Output

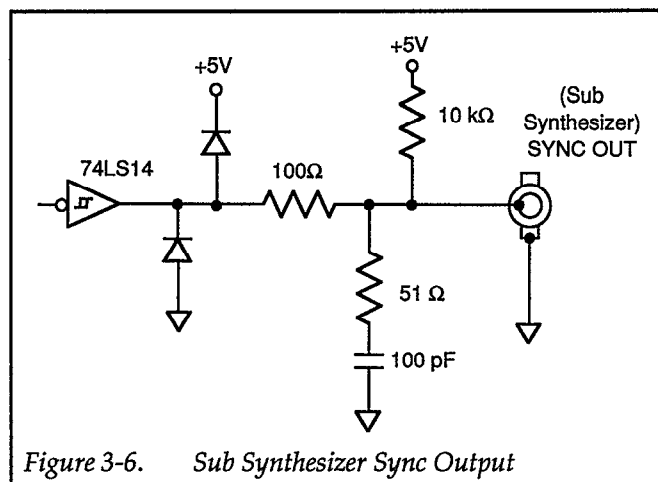

Figure 3-6. Sub Synthesizer Sync Output

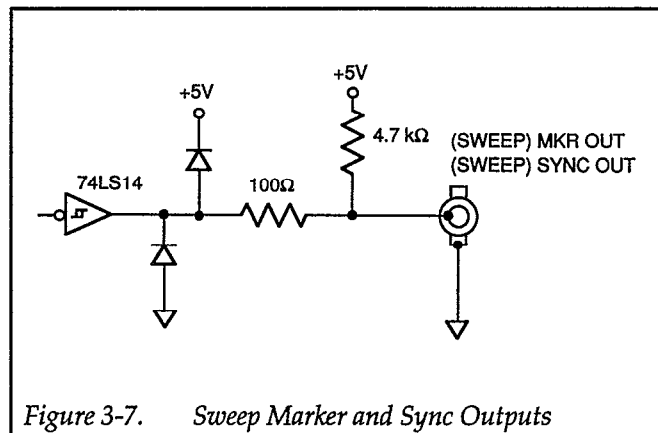

Figure 3-7. Sweep Marker and Sync Outputs

Output Considerations

All logic outputs except for the main synthesizer waveform synchronous output are driven by a 74LS14 buffer. Be careful not to connect a load that results in exceeding the drive capability of this TTL IC. Also, do not use excessively long connecting cables, as the resulting capacitance may have detrimental effects on the output signals.

The main synthesizer synchronous output impedance is matched at approximately 50Ω. Best waveform quality will be obtained if 50Ω coaxial cables, terminated with a 50Ω impedance, are used.

The sub synthesizer synchronous output impedance is matched at approximately 50Ω at higher frequencies. Relatively good waveforms will be obtained if 50Ω coaxial cables are used; however, the cables must not be terminated with a 50Ω impedance.

The main synthesizer waveform output impedance is 50Ω. To maintain consistent amplitude across the entire bandwidth, and for maximum square-wave quality, use a 50Ω coaxial cable for connections, and terminate the opposite end of the cable with a 50Ω impedance. The actual output voltage will be displayed by the Model 3940 if the output amplitude display is set for 50Ω loads.

3.4 STARTUP

1. Check that the supply voltage switch is set to the proper position for the supply voltage. The allowable supply voltage range is ±10% of the voltage at which the supply voltage switch is set.

CAUTION

Operating the Model 3940 in an incorrect line voltage may result in damage to the unit.

2. Make sure that the power is off, then plug the supplied power cable firmly into the LINE connector on the rear panel of the Model 3940. Insert the power plug into a grounded AC power receptacle.

WARNING

To avoid the possibility of electric shock, use only grounded AC receptacles for power connections.

Turn on Model 3940 power by pressing in on the front panel POWER switch. Power is ON when the POWER switch button is depressed (in); power is OFF when the POWER switch button is released (out). When the power is turned on, the Model 3940 will begin normal operation, and the liquid crystal display backlight will turn on.

3. When the power is first turned on, the Model 3940 will return to the previous settings effective prior to power-off, and the unit will display the main synthesizer main parameters.

If the previous settings were not stored correctly, the error code "Er MEMO 14" will be displayed, and the preset settings will be placed into effect. At this point, main synthesizer main parameters will be displayed, and the settings prior to preceding power-off will be lost. This situation occurs when the backup battery used to maintain memory has insufficient charge, and stored data cannot be maintained. A fully-charged battery can retain memory for approximately 60 days. This time period, however, varies slightly with ambient temperature and from one battery to another. Approximately 50 hours with unit power turned on are required to fully charge a dead battery.

When the battery becomes too weak for practical use, contact your Keithley representative or the factory for information on obtaining a replacement.

4. The backup battery may be discharged when the Model 3940 is used for the first time after being purchased, or if the unit has not been turned on for a considerable length of time. Turn on power for at least several hours to charge the battery.
5. Sweep operation mode parameters are not stored when the power is turned off. Therefore, turning the power off during sweep operation, sweep hold, end of single sweep, start frequency output, or stop frequency output, will result in a sweep-off state the next time power is turned on.

In addition, turning the power off during calibration cancels the calibration process, and calibration operation will not automatically restart when power is turned back on.

6. If the error code "Er MEMO 14" is displayed at power-on, the main synthesizer amplitude accuracy may not be within the specified range. In this situation, wait for a few seconds after power-on, then perform calibration by pressing the CAL key.
7. If, at power on, the Model 3940 does not enter the mode with settings that were effective immediately before previous power-off (or the preset operating modes), or if the main display does not appear, contact your Keithley representative or the factory to determine the correct course of action.

NOTES:

1. Wait for at least five seconds before turning on the Model 3940 after turning it off.
2. For high-accuracy measurement applications, allow the Model 3940 to warm up for at least 30 minutes to allow internal circuits to stabilize.



3.5 OPERATING PROCEDURES



3.5.1 Setting Parameters Using Numeric Keys

When the appropriate parameter key such as **FREQ**, **AMPTD**, **OFFSET**, or **PHASE** is pressed, the parameter name and the present parameter value will be indicated in the upper part of the liquid crystal display. The allowed range of the parameter setting and useful help information will appear in the lower part of the liquid crystal display.

The parameter value can be changed when the parameter name indicated in the upper part of the liquid crystal display is flashing. The parameter name will not flash when the unit is in the GPIB remote mode, or when the front panel lock is enabled.

Parameters that are selected by pressing one numeric character (such as waveform, oscillation mode, and trigger source), can be changed simply by pressing the corresponding numeric key. An error message will be displayed if the entered value is outside the allowed range. Other displays and internal settings remain unchanged when an error occurs.

Example: Changing the waveform type from the current  (sine wave) to  (square wave) or to  (triangular wave).

Key Operation	Display Result
Press FCTN.	Currently selected waveform (<SIN>1) will be displayed.
Press 3	Waveform changes to  >3 (square wave).
Press 2	Waveform changes to  >2 (triangle wave).

Parameters that require units, such as frequency, amplitude, and phase, can be changed by entering the new value with the numeric keys and pressing the appropriate **ENTER** key to complete the parameter entry process. While entering the new value, the current parameter value, unit display, and modification step size will disappear from the display, and the new value will be displayed. To correct an entered value during the entry process, press the **RUB OUT** key, which will delete one character at the rightmost position of the entered number. To re-enter the entire parameter value from the beginning, press the same parameter key to return to the corresponding parameter setting.

For frequency and amplitude, which have several units options, select and press the appropriate units key to complete the entry process. For phase and marker frequency parameters, which have only single parameter units, press any one of the **ENTER** keys to complete entry.

Regardless of the number of digits for the entered value and the size of the units (MHz, kHz, Hz; sec, msec, sec; V, mV; or Vrms, mVrms), the predetermined number of digits, resolution, and units will all be properly adjusted and displayed. When values below the display resolution are entered with the numeric keys, the value will be rounded to the nearest whole number and set accordingly.

When inappropriate values are entered, an error message will be displayed and the display will return to the previous value. Internal settings will remain unchanged when an error condition occurs.

Example: To change frequency from a current value of 1Hz to 2.54Hz. (Correcting an entered value of "2.55" during entry.)

Key Operation	Display
Press FREQ	Currently selected frequency "1.0000Hz" will be displayed.
Press 2	The value of the key pressed (2) will appear.
Press .	The decimal point appears to the right of the 2.
Press 5	The display now shows "2.5".
Press 5	The display indicates "2.55".
Press RUB OUT	The last 5 is deleted, and the display reads "2.5".
Press 4	The display indicates "2.54".
Press Hz	Entry is complete, and the display shows "2.5400Hz"

3.5.2 Setting Parameters with MODIFY

You can change parameter values with the MODIFY knob and cursor keys in the following cases:

1. When the name of the parameter to be changed is blinking in the upper part of the liquid crystal display. (The parameter name indicated in the upper part of the liquid crystal display will not flash when the unit is in the GPIB remote, or when the keyboard lock is on.)
2. In the situation in step 1, the current value specified is displayed, and the modification step size is presented in the upper right corner of the liquid crystal display. (Modification step size will not be displayed during numeric key input. Modification cannot be performed during numeric input.)

For parameters that are selected with one numeric character (such as waveform and oscillation mode), the flashing cursor is fixed below the numeric character and cannot be moved. The step size is fixed to ± 1 and cannot be changed.

For parameters that require units (such as frequency and amplitude), the step size can be changed by pressing the STEP SIZE key. It is not necessary to use a units key when changing the value with the MODIFY knob. When modifying an existing value, the modified value will automatically replace the old parameter value, and the current units will remain unchanged.

When the step size is indicated in the rightmost position of the liquid crystal display, the step size will change in the following order each time the STEP SIZE key is pressed: $\pm 1 \times +2 \times +10 \pm 1 \dots$

When the step size is ± 1 , you can specify the digit for UP/DOWN adjustment by placing the flashing underline cursor under the appropriate digit with the cursor keys, and turning the MODIFY knob to the right or left. When the step size is $\times +2$ or $\times +10$, the cursor will disappear, and you can multiply or divide by 2 or 10 by turning the MODIFY knob to the right or left. The step size and the current cursor position will be stored with the respective parameters when those parameters are stored in memory.

Changing a value by modification will never result in an error because the modification process automatically limits parameter adjustments to the maximum allowed range for that particular parameter. MODIFY cannot be used to store or recall memory locations, or to set the GPIB address and delimiter; only the numeric keys can be used to program these operating modes.

3.5.3 Error Codes

When an error occurs, the Model 3940 displays an error code in the upper right corner of the liquid crystal display, and the unit generates a long beep sound (if the beep sound setting is on). The Model 3940 then displays the current specified parameter value.

Displayed error codes and their meanings are summarized below. The error number at the end of each code corresponds to the GPIB error code.

Er GPIB01

- The Model 3940 received a non-recognizable programming or inquiry command over the GPIB.

Examples:

"ABC 2" Non-recognizable programming command is given.

"?ABC": Non-recognizable inquiry command is given.

"123.4": Parameter values are given without headers.

- The Model 3940 received a command that is not recognized in the current mode.

Examples:

Main synthesizer frequency setting command is given during sweep operation.

Amplitude setting command is given during calibration operation. (Only the calibration stop command is acceptable during calibration operation.)

- The Model 3940 received a command string that is beyond the capacity of the GPIB input buffer.

Er UNIT02

- You attempted to specify an incorrect parameter unit

Examples:

You pressed the dBm key while setting the sub synthesizer amplitude.

You pressed the Vrms key while setting the offset voltage.

- You attempted to select an unacceptable unit for other settings.

Example:

You attempted to specify an amplitude value other than p-p for a DC or arbitrary waveform type.

Er FREQ03

- You attempted to specify a main synthesizer frequency setting above 25MHz.
- You attempted to specify a main synthesizer period setting outside the allowed range of 0.04 μ sec to 10,000sec.
- You attempted to specify a sweep start, stop, center, span, or marker frequency or period parameter outside the allowed range.
- You attempted to specify a value that causes the resulting start or stop frequency to exceed the allowed sweep center or span frequency (period) range.

Example:

You attempted to specify a 15MHz center frequency when the span frequency is 20MHz. (You have attempted to specify 5MHz for start frequency and 35MHz for stop frequency.)

- You attempted to set the sub synthesizer frequency higher than 100kHz.
- You attempted to specify a sub synthesizer period outside the allowed range of 10 μ sec to 10,000sec.

Er PHAS04

- You attempted to specify a phase setting value greater than $\pm 360^\circ$.

Er AMPT05

- You attempted to specify main synthesizer amplitude setting outside the range specified in Table 3-1.
- You attempted to specify a sub synthesizer amplitude setting outside the range specified in Table 3-2.

Er OFST06

You attempted to specify a DC offset value greater than $\pm 10V$ /no load or $\pm 5V$ /50 Ω load.

Table 3-1. Main Synthesizer Amplitude Range











Waveforms	Amplitude with No Load	Amplitude with 50Ω Load
	20.0Vp-p/no load to 2.00mVp-p/no load 7.07Vrms/no load to 0.71mVrms/no load 16.9dBV/no load to -63.0dBV/no load	10.0Vp-p/50Ω to 1.00mVp-p/50Ω 3.53Vrms/50Ω to 0.36mVrms/50Ω 10.9dBV/50Ω to -69.0dBV/50Ω 23.9dBm/50Ω to -56.0dBm/50Ω
  	20.0Vp-p/no load to 2.00mVp-p/no load 5.77Vrms/no load to 0.58mVrms/no load 15.2dBV/no load to -64.7dBV/no load	10.0Vp-p/50Ω to 1.00mVp-p/50Ω 2.88Vrms/50Ω to 0.29mVrms/50Ω 9.2dBV/50Ω to -70.7dBV/50Ω 22.2dBm/50Ω to -57.8dBm/50Ω
	20.0Vp-p/no load to 2.00mVp-p/no load 10.0Vrms/ no load to 1.00mVrms/no load 20.0dBV/no load to -60.0dBV/no load	10.0Vp-p/50Ω to 1.00mVp-p/50Ω 5.00Vrms/50 Ω to 0.50mVrms/50Ω 13.9dBV/50Ω to -66.0dBV/50Ω 26.9dBm/50Ω to -53.0dBm/50Ω

Table 3-2. Sub Synthesizer Amplitude Range

Waveforms	Amplitude with No Load
	20.0Vp-p/no load to 0.2Vp-p/no load 7.07Vrms/no load to 0.1Vrms/no load 17.0dBV/no load to -23.0dBV/no load
  	20.0Vp-p/no load to 0.2Vp-p/no load 5.7Vrms/no load to 0.1Vrms/no load 15.2dBV/no load to -24.7dBV/no load
	20.0Vp-p/no load to 0.2Vp-p/no load 10.0Vrms/no load to 0.1Vrms/no load 20.0dBV/no load to -20.0dBV/no load

Er ACDC07

With a waveform other than DC and a non-zero DC offset (in other words, the DC offset was to be added to the AC waveform), you attempted to specify an invalid amplitude or DC offset value.

The following restrictions apply when adding DC offset to the AC waveform:

- AC amplitude setting [Vp-p] + 2 + |DC offset voltage setting [Vp-p] | ≤10V with no load
≤5V with 50Ω load.
- The amplitude setting must be equal to or larger than the minimum AC amplitude determined by the sum of the voltages above. In addition, the DC offset must not be added to limit the above restrictions. See Table B-4 (Appendix B) and paragraph 3.5.8 for more details on these restrictions.

Er FRDT08

You attempted to set the main synthesizer to output square waves with variable duty cycle at a frequency greater than 1MHz.

Examples:

You attempted to vary the square-wave duty cycle from 50% variable when the frequency is greater than 1MHz with a  waveform.

You attempted to set the frequency above 1MHz with the unit set to output square waves with variable duty cycle.

Er SPLV09

You attempted to set the main synthesizer oscillation frequency above 1MHz with a RESET stop level mode and an oscillation mode other than CONT.

Examples:

You attempted to change the stop level from HOLD to RESET with the unit set to the TRIG oscillation mode at a frequency greater than 1MHz.

You attempted to change the oscillation mode from CONT to BRST with the unit set to the RESET stop level at a frequency greater than 1MHz.

You attempted to set the oscillation frequency above 1MHz with the unit set to the RESET stop level and the GATE oscillation mode.

Er MODE10

You attempted to set the main synthesizer oscillation frequency above 10MHz with an oscillation mode other than the CONT.

Examples:

You attempted to set the oscillation frequency to 12MHz with the unit set for the GATE oscillation mode.

You attempted to change the oscillation mode from CONT to BRST with the frequency set to 11MHz.

Er SWP11

- You attempted to perform sweep operations with an invalid sweep range and sweep time.

Examples:

You attempted to perform a LOG sweep operation with the sweep set below 1 octave.

You attempted to begin a sweep operation with the sweep start frequency and the sweep stop frequency set to the same frequency.

- You attempted to change the sweep time and the sweep range invalid values during sweep operation.

Example:

You attempted to set the sweep start frequency and sweep stop frequency to the same frequency during sweep operations.

Er RNGE12

You attempted to specify a value outside the predetermined range, resulting in a condition other than errors 03 through 11.

Examples:

You entered a value of 9 during waveform selection.

You attempted to set the sweep time to 1msec.

Er CNVT13

The result of the units conversion is outside the allowed range of the given value.

Example:

You attempted to display period units when the frequency is set to 0Hz.

Er MEMO14

- An error was found in the backup memory at power on for one or more parameter settings. If this error occurs, preset settings will be placed into effect, and you should perform front panel calibration after waiting a few seconds.
- An error was found in the contents of the memory while recalling parameters. Parameter settings will not be changed, and the Model 3940 will return to the prompt for the memory number to recall.

Er SYNC15

The slave unit has detected that the power of the master unit is not turned on during synchronous operation (the slave unit will not operate properly if the power of the master unit is off). If the slave unit detects that the power of the master unit is off, the signal output will be turned

off, and the error display will appear. The Model 3940 slave unit will not recognize further parameter settings until the power of the master unit is turned on and the error condition is corrected.

Er CAL16

An error has occurred during calibration operations (this error indicates that the Model 3940 is malfunctioning). When this error occurs, calibration operations will be terminated, and amplitude accuracy will not be guaranteed.

3.5.4 Units Conversion

The Model 3940 can display both frequency and amplitude in different units (frequency can be displayed as period or frequency, while amplitude can be displayed in p-p, rms, or dB units). You can convert from one type of units to another by pressing the appropriate units key when the Model 3940 is in the appropriate parameter-setting mode.

Example:

Assume that the Model 3940 is in the frequency-setting mode and displays a current frequency of 1.000 000 0kHz. Pressing sec, ms, or μ s converts from frequency to period units, and the unit displays 1.00000msec.

Note that internal settings remain unchanged when the units conversion is performed. The Model 3940 automatically displays the result of units conversion as the current specified value, and you can modify the value using the converted units, if desired.

Frequency Units Conversion

Frequency to period: Press the sec, ms, or μ s key when the Model 3940 is displaying frequency.

Period to frequency: Press the MHz, kHz, or Hz key when the Model 3940 is displaying period.

The actual, specified value is always displayed for the frequency, and the frequency accuracy specifications stated in Appendix B apply. However, the period displayed is the result obtained by rounding off the reciprocal of a given frequency to the predetermined number of digits according to the selected resolution (the reciprocal

is truncated for values lower than the resolution) and the result is displayed. Note, therefore, that the period displayed as the result of units conversion contains a larger error when the programmed frequency is high.

Example:

Assume that a main synthesizer frequency of 19.417 475 740 0MHz (actual period of 0.0515 μ sec) is converted to period display. The value is rounded and displayed as 0.051 μ sec because of a 1nsec resolution limitation. The result is an error equivalent to 0.97% of the correct period.

Amplitude Units Conversion

p-p, rms, or dBm to dBV: Press the dBV key when the Model 3940 displays the p-p, rms value, or dBm value.

p-p, dBV, or dBm to rms: Press the Vrms or mVrms key when the Model 3940 displays the p-p, dBV, or dBm value.

rms, dBV, or dBm to p-p: Press the V or mVrms key when the Model 3940 displays the rms, dBV, or dBm value.

p-p, rms, or dBV to dBm: Press the dBm key when the Model 3940 displays the p-p, rms, or dBV value.

3.5.5 Frequency Programming

Pressing the **FREQ** key displays the current main synthesizer frequency and enables main synthesizer frequency programming. (During a sweep or sweep hold, however, the frequency cannot be programmed, but the current frequency can still be displayed by pressing **FREQ**.) Pressing **SUB FREQ** displays the current sub synthesizer frequency and enables sub synthesizer frequency programming.

To program the frequency using the numeric keys, press the MHz, kHz, or Hz key after entering the value. The resolution of a frequency value is 0.1mHz. When the specified frequency is below 1kHz, the value will be displayed in kHz units. Above 1kHz and below 1MHz, the frequency will be displayed in kHz units, and above 1MHz, the frequency will be displayed in MHz units. To specify the frequency in period units instead of frequency units, press one of the time period keys (sec, ms, or μ s). Frequency programming for sweep operations is identical.

The main synthesizer accepts a maximum of six digits and has a resolution of 1nsec. The actual oscillation fre-

quency is obtained by truncating the reciprocal of the given value to an acceptable number of digits on the part of the value smaller than 0.1mHz.

The sub synthesizer accepts a maximum of six digits with a resolution of 100ns. The actual oscillation frequency is obtained by truncating the reciprocal of the given value to an acceptable number of digits on the part of the value smaller than 0.1mHz.

When frequency programming is enabled, you can change the present value with the MODIFY knob. The knob can be used to change the value during both frequency display and period display. When the step size is ± 1 , you can select the digit to change by placing flashing underline cursor under the appropriate digit and turning the MODIFY knob to the right or left. When the step size is $\times +2$ or $\times +10$, the cursor will disappear, and you can divide or multiple the value by 2 or by 10 by turning the knob to the left or right.

Note that when the displayed period is obtained from a frequency specified with an insufficient number of digits, the actual oscillation frequency may not be changed even if the value is changed with a numeric key or the MODIFY knob. The Model 3940 always displays a correct value for frequency.

3.5.6 Amplitude Programming

Pressing AMPTD displays the current main synthesizer amplitude and enables main synthesizer amplitude programming. Similarly, pressing SUB AMPTD displays the present sub synthesizer amplitude and allows sub synthesizer amplitude programming.

When using numeric keys to set the amplitude, press the appropriate units key to complete the entry process. Press V or mV to enter p-p units, use Vrms or mVrms for rms units, or press dBV or dBm for dB units. Note that dBm units do not apply to the sub synthesizer amplitude, and that only dBV and dBm units can have negative values.

The rms and dBV values are set on the assumption that the average or center level of the peak-to-peak amplitude of the waveform is 0V. Thus, these values do not depend on the DC offset value or square-wave duty cycle. As

when setting the frequency, you can use MODIFY to change the amplitude.

The AMPTD key sets the amplitude for AC waveforms only; use the OFFSET key to set the DC output voltage of the DC waveform type. When the DC waveform is selected, you still can program the amplitude, but that value can be entered only in p-p units (the allowed amplitude ranges from 2.00mV p-p/no load to 20.0V p-p/no load). The specified value is stored, and it is used as the given amplitude for the next selected AC waveform.

For AC waveforms with 0V DC offset, you can specify any value within the maximum and minimum allowed amplitude limits without restrictions. If, however, the programmed DC offset is not 0V, certain restrictions concerning the maximum allowable amplitude apply. Paragraph 3.5.8 describes these restrictions in more detail.

When the main synthesizer amplitude is changed, an offset voltage may appear at the output jack for less than 1msec until the output stabilizes at its new value. In addition, an amplitude setting change that causes output attenuator switching may cause the output to be turned off for about 100msec during switching.

3.5.7 DC Offset Programming

Pressing the OFFSET key displays the current DC offset value and enables main synthesizer offset programming. Note that the DC offset is programmable only for the main synthesizer; the sub synthesizer has no programmable offset.

When using the numeric keys to set the offset, press the V or mV key after entering the value to complete the entry process. As with other parameters, you can also use MODIFY to change an existing offset value.

With a DC waveform, the programmed offset voltage is the DC voltage value that appears at the output jack. Valid offset values are within the range of +10V to -10V.

For all AC waveforms, the DC offset is added to the average value of the peak-to-peak amplitude of the AC waveform. Certain restrictions apply for amplitude-offset combinations, and some combinations of values may cause an error (Er ACDC07) to occur. See paragraph 3.5.8 below for more details.

When a DC offset setting that causes a change in output attenuators is programmed, the output may be turned off for approximately 100msec during the switching period.

3.5.8 AC Amplitude and DC Offset Relational Restrictions

AC amplitude and DC offset settings are subject to relational restrictions. See Table B-4 (Appendix B) and Figure 3-8 for more details on the interaction between these two parameters.

These restrictions are a result of the limitations in the maximum output voltage of the output amplifier. When the DC offset is added to the AC waveform, the output voltage peak will be the sum of the DC offset voltage and half of the AC waveform amplitude. This voltage is known as the total set voltage and is related as follows:

$$\text{Total Voltage} = \frac{\text{Set AC amplitude (Vp-p)}}{2} + |\text{Set DC offset voltage (V)}|$$

Example:

An error will occur when you try to set the DC offset to 6V/open when the amplitude is 10V p-p/open. (The total voltage exceeds 10V/open.)

Example:

An error will occur when you try to set the amplitude to 100mV p-p/open when the DC offset is 5V/open. (The minimum AC amplitude when the total voltage is over 1V/open is 200mV p-p. The amplitude setting is below the minimum amplitude value.)

Even valid combinations may cause errors in the process of setting up those combinations. To avoid such errors, reset the DC offset value to 0V before changing the amplitude, or change the setting specified in Figure 3-8 so that the values are within the range of allowed settings.

Example:

Suppose that the current amplitude is 100mV p-p/open and the DC offset is 500mV/open. Assume that you want to use an amplitude of 500mV p-p/open and a DC offset of 5V in combination. An error will occur if you set the DC offset to 5V before setting the amplitude. (The minimum AC amplitude when the total voltage is over 1V/open is 200mV p-p. The amplitude setting is below the minimum amplitude value.) If you set the amplitude to 500mV p-p first, and then set the DC offset to 5V, you can obtain the desired amplitude and offset values without causing an error.

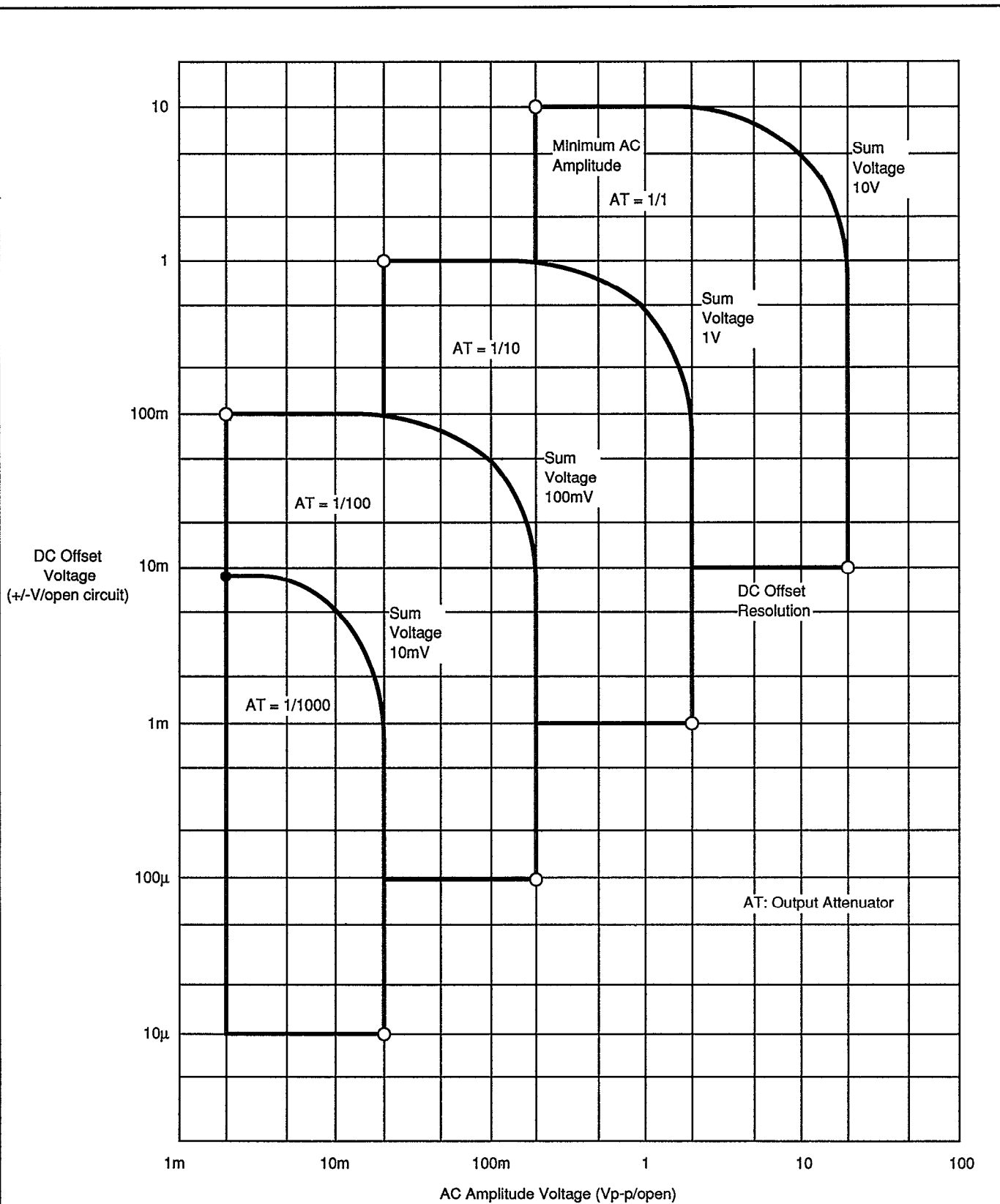

Figure 3-8. Relational Range for Allowed AC Amplitude Voltage and DC Offset Voltage

3.5.9 Waveform Selection, Square-Wave Duty Factor, and Synchronous Output

Waveform Selection

Pressing the FCTN key displays the current main synthesizer waveform along with its corresponding number and enables main synthesizer waveform selection. Available main synthesizer waveforms include: DC, SIN (\sim), \wedge , \sqcap , \nearrow , \searrow , and ARB.

Pressing SUB FCTN displays the current sub synthesizer waveform along with its with its corresponding number and enables sub synthesizer waveform selection. Sub synthesizer waveforms include: SIN (\sim), \wedge , \sqcap , \nearrow , and \searrow .

To select a waveform with the numeric keys, simply press the numeric key that corresponds to the desired waveform. For example, press 1 to select a sine wave. The waveform will change immediately when the corresponding key is pressed; it is not necessary to press a units key.

When the Model 3940 displays the current waveform, and function parameter selection is enabled, you can change the waveform by turning the MODIFY knob. Turning the knob clockwise increases waveform numbers, while turning the knob counter-clockwise decreases waveform numbers (one number increment per knob detent). When the highest or lowest waveform numbers are reached, the number will wrap around to the lowest or highest selection (main synthesizer numbers range from 0 through 6, and sub synthesizer numbers are from 1 to 5).

For all AC waveforms, the p-p value of the amplitude will remain unchanged when you change the waveform. If the amplitude is specified in units other than a p-p value, the amplitude will be converted to p-p units when the waveform is changed.

Square-Wave Duty Cycle

The duty cycle is the ratio of the time period of the waveform high-level duration to the time period of one

complete cycle of the waveform expressed as a percentage. For example, a 10kHz square wave has a time period of 100 μ sec. If the high portion of the waveform has a period of 30 μ sec, the duty cycle is $30/100 \times 100 = 30\%$.

Two square-waveform duty-cycle modes are available: one with the duty cycle fixed at 50% and the second mode with a variable duty cycle. The duty cycle applies only to the square-wave function (waveform 3), although the duty cycle can be programmed while other waveforms are selected.

To change the duty cycle, press the \sqcap DUTY key, and enter or modify the duty cycle (5.0% to 95.0%). The Model 3940 stays in the variable duty cycle mode even if you set the duty cycle to 50%. To select the fixed 50% duty cycle mode, press SHIFT FXD50. In the duty cycle display mode, the Model 3940 displays "FXD" for the 50% fixed mode or "VAR" for the variable duty-cycle mode.

When the Model 3940 is in the variable duty-cycle mode, the upper-frequency limit is 1MHz, and the maximum jitter is 15nsec or less. The Model 3940 has a resolution of 0.1% for duty-cycle display, but the hardware resolution is 0.4% (8 bits). As a result, if you make a duty-cycle change lower than the hardware resolution cycle, only the displayed value will change, not the duty cycle of the actual output.

To extend the duty cycle range, use the burst oscillation mode and one square waveform cycle.

Example:

Set the mark number of cycles to 1 cycle, the space number of cycles to 9 cycles, the phase to -90° , and the stop level to HOLD with the unit in the burst oscillation mode. With these settings, the square-wave duty cycle will be 10%.

Synchronous Output

Figure 3-9 illustrates the phase relationship between the waveform and synchronous outputs at frequencies below 1kHz. Typical jitter between the main synthesizer waveform output and the main synthesizer synchronous output is about 9.1nsec. Typical jitter between the sub synthesizer waveform output and the sub synthesizer synchronous output is approximately 291nsec.

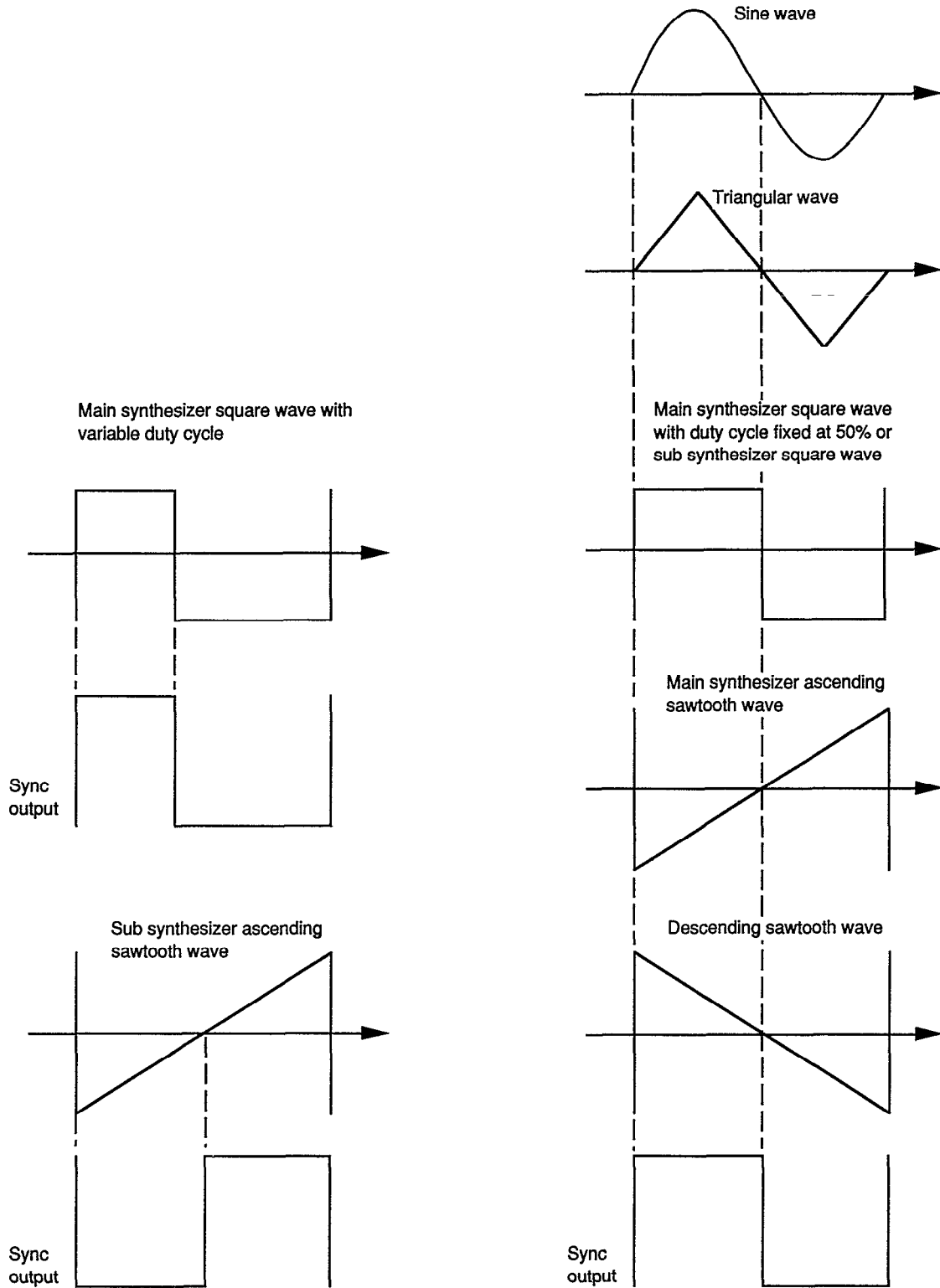

Figure 3-9. Phase Relationship Between Waveform and Synchronous Output

3.5.10 Oscillation Mode and Trigger Source Selection

Oscillation Mode Selection

Pressing the MODE key displays the current main synthesizer oscillation mode along with its corresponding number and enables main synthesizer oscillation mode selection. Available oscillation modes include continuous, burst, trigger, and gate modes. These oscillation modes are applicable only to the main synthesizer and do not apply to the sub synthesizer.

To select the oscillation mode with the numeric keys, simply press the numeric key that corresponds to the desired oscillation mode. For example press 1 to select the burst mode. Pressing the numeric key will change the setting immediately; it is not necessary to press a units key when setting the oscillation mode.

When the Model 3940 displays the current oscillation mode and mode selection is enabled, you can also change the mode by turning the MODIFY knob. Turning the knob clockwise increases the oscillation mode number, while turning the knob counter-clockwise decreases the oscillation mode number (one digit per detent setting). When the highest or lowest mode number is reached, the number will wrap around to the lowest or highest value (mode values range between 0 and 3). Note that the cursor position is fixed, and the step size is fixed at ± 1 .

Continuous Mode

When the continuous mode is selected, the instrument will generate the selected waveform continuously. Triggering or gating is not required, and the selected mark

and space values will have no effect on the output waveform.

Burst Mode

In the burst mode, the instrument will generate the selected waveform for the number of mark cycles and then stop oscillations for the number of space cycles. This on-off cycle of oscillations will be generated repeatedly.

For example, if the number of mark cycles is set to 1.5 cycles and the number of space cycles is set to 4.0 cycles, the unit will oscillate for 1.5 cycles and will stop oscillations for 4 cycles repeatedly. Figure 3-10 demonstrates the on-off characteristics of the burst oscillation mode.

Trigger Mode

In the trigger mode, the unit will generate the number of cycles of oscillation determined by the mark parameter each time the trigger signal is received. The Model 3940 will ignore other trigger signals while generating the specified number of waveform cycles. In other words, a trigger functions only when the Model 3940 is not generating oscillations.

For example, if the mark parameter is set to 2.0 cycles, and a trigger signal is received, the Model 3940 will oscillate for 2 cycles. Any trigger signal received will be ignored during this period. When the 2-cycle oscillation period is completed, the Model 3940 will begin the oscillation stop phase, and triggers will then be enabled.

Figure 3-11 demonstrates the trigger oscillation mode. Note that the source of the trigger is programmed with the SOURCE key.

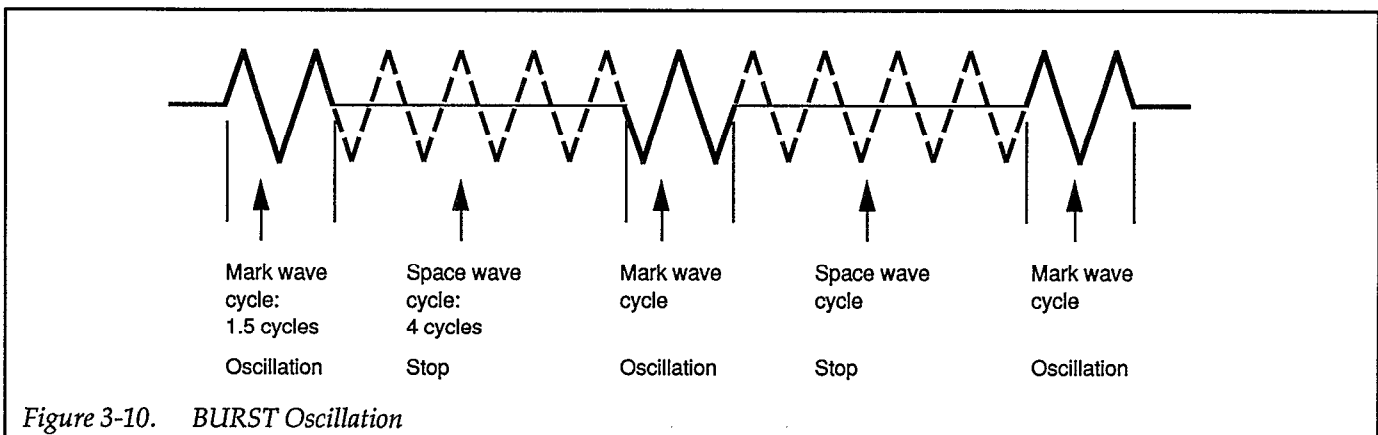

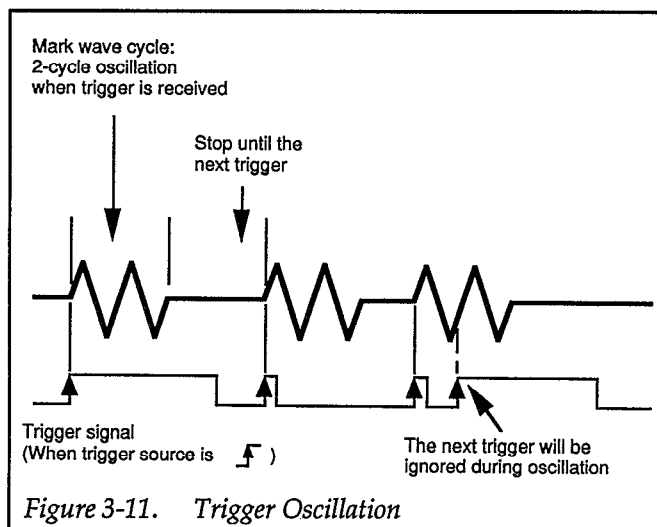

Gate Mode

In the gate mode, the unit will generate oscillations as long as the gate signal (trigger signal) is on. When the gate signal turns off, the Model 3940 will always stop oscillating at half-period point of the cycle even if the gate signal turns off before the half-period point of the cycle is reached. These gate mode characteristics are shown in Figure 3-12.

For example, oscillation starts when the gate signal (trigger signal) turns on with the unit in the oscillation stop mode. If the gate signal goes off after 4.1 cycles, oscillation will not stop immediately at this point but will continue until 4.5 cycles have been generated. Once this point is reached, the unit will enter the oscillation stop mode, and oscillations can be restarted by the gate signal.

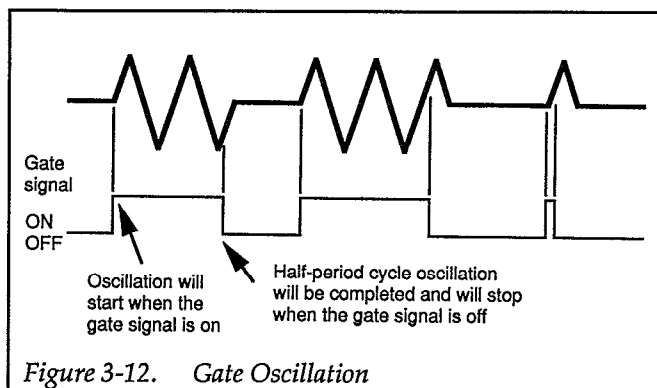

Trigger Source Selection

Pressing TRIG SOURCE displays the current trigger source with its corresponding number and enables trigger source selection. Available trigger sources include external (a trigger signal applied to the EXT TRIG IN jack), and internal (sub synthesizer sync signal). Rising-edge (\nearrow) and falling-edge (\searrow) signals can be selected for both external and internal trigger sources. Note that selecting internal trigger automatically selects the sub synthesizer synchronous output signal as a trigger source.

In the trigger oscillation mode, the trigger will be generated on the rising edge of the input signal if \nearrow is selected or on the falling edge of the input signal if \searrow is selected. Similarly, in the gate oscillation mode, the gate signal is considered to be on at a high logic level in the \nearrow mode, and the gate signal is considered to be on at a low logic level in the \searrow mode.

In the gate oscillation mode with the trigger source set to external \nearrow , the gate signal will be on, and the Model 3940 will oscillate continuously when the EXT TRIG IN BNC connector is left disconnected. This situation is the result of the internal pull-up resistor connected to the external trigger input. Thus, leaving the external trigger input connector disconnected is equivalent to connecting a high logic level.

3.5.11 Mark, Space, and Phase Parameter Programming

Mark and Space Parameter Programming

Pressing the MARK key displays the current mark parameter and enables mark parameter programming. Similarly, pressing the SPACE key displays the present space parameter and enables space parameter programming.

To program the mark and space parameters using the numeric keys, key in the desired value, and press any one of the ENTER keys to complete the entry process.

The allowed range for the mark and space parameters is from 0.5 cycle to 32768.0 cycles with 0.5 cycle resolution. The fractional part of input values will be rounded to .0 or .5.

When the Model 3940 displays the current mark or space value, and parameter entry is enabled, you can change the mark or space value with the MODIFY knob.

When the step size is ± 1 , you can specify the digit to modify by placing the flashing cursor under the appropriate digit and turning the MODIFY knob to the right or left. When the step size is $\times +2$ or $\times +10$, you can divide or multiply the value by the step size by turning the MODIFY knob to the left or right.

The mark parameter applies to both the burst mode and trigger modes, and the same value is used by both. However, the space parameter applies only to the burst mode. Either parameter can be programmed while the instrument is in any oscillation mode, but they will be in effect only for the applicable modes (burst or trigger).

Phase

Pressing PHASE displays the current main synthesizer phase and allows setting of that parameter. Similarly, pressing SUB PHASE displays the present sub synthesizer phase and enables sub synthesizer phase programming. The allowed range for both main and sub synthesizer phase parameters is from -360.0° to 360.0° with 0.1° resolution.

Phase definitions for the available waveforms are illustrated in Figure 3-13.

The Model 3940 generates the main synthesizer sine wave synchronous output, as well as square waves with fixed 50% duty factor and their synchronous output by processing sine waves with a zero-crossing comparator that has hysteresis. The level of the generated square wave, therefore, alternates high and low at approximately 0° , $\pm 180^\circ$, and $\pm 360^\circ$ depending on the history (past value) of the phase.

Note that the unit may generate distorted waveforms caused by overshoots for oscillation modes other than CONT during the transition to the stop phase. To set the start/stop level high, set the start/stop phase to a high value; to set the start/stop level low, set the start/stop phase to a low value.

Other main synthesizer waveform synchronous outputs and square waves of variable duty factor are generated digitally. Maximum jitter for these waveforms is 15nsec (9.1nsec typical).

Main synthesizer phase settings apply to the start phase of the burst oscillation, trigger oscillation, and gate oscillation modes of the main synthesizer. When oscillation begins from the oscillation stop mode, oscillation will resume from the phase specified with this phase setting.

This phase setting can also be used as an oscillation resume phase when phase sync is used. See paragraph 3.5.12 for more details.

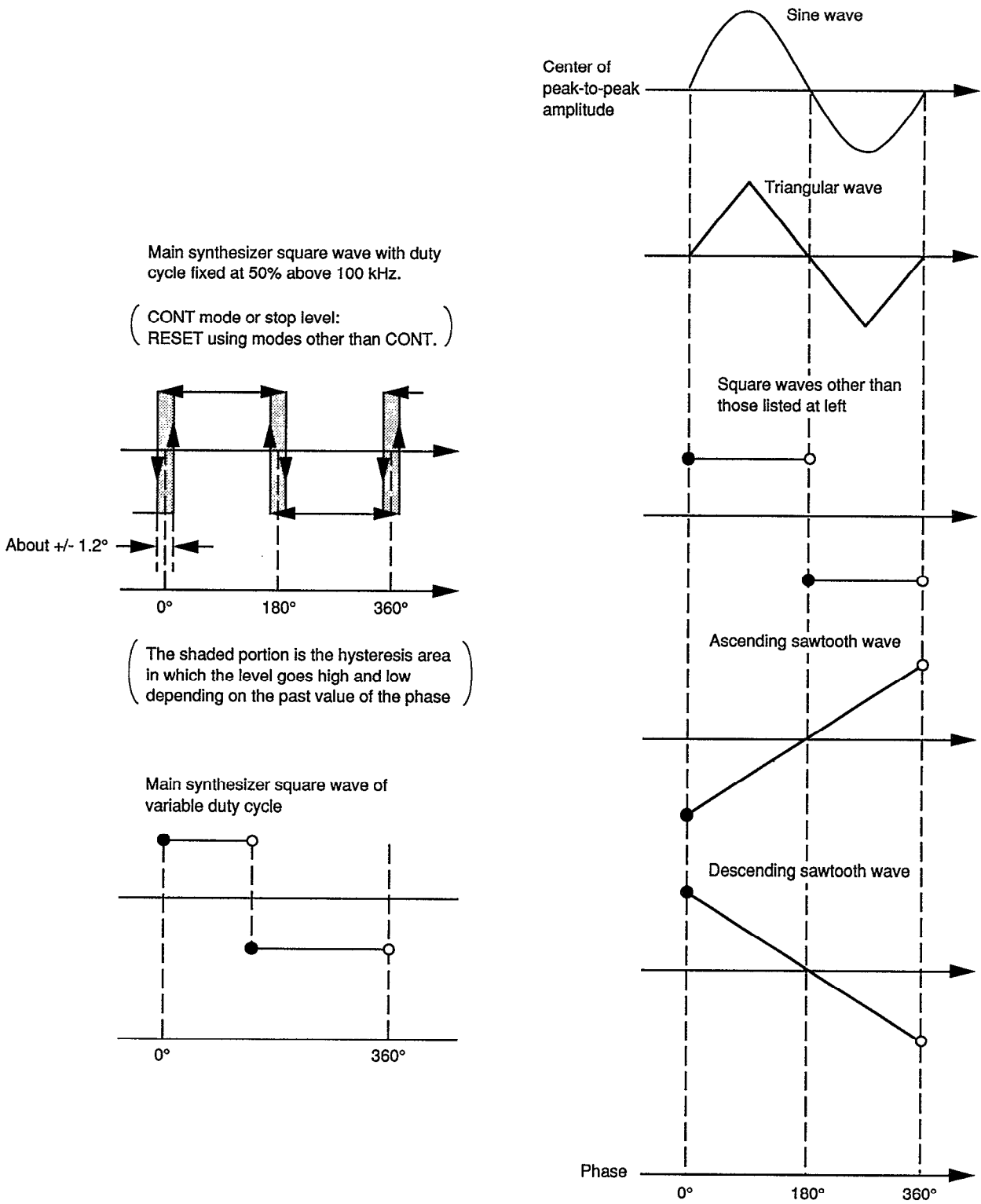

Figure 3-13. Waveforms and Phase Definitions

3.5.12 Stop Level and ϕ SYNC

Stop Level Selection

Pressing SHIFT STOP LEVEL enables stop level programming. The stop level applies to the burst oscillation, trigger oscillation, and gate oscillation modes, and it determines the output level during the oscillation stop mode.

The Model 3940 has two stop level modes: HOLD (0) and RESET (1). With the HOLD mode, the oscillation stop level is set to the same value as the output level at the oscillation start phase. With the RESET mode, the output is set to the center value of the waveform during the oscillation stop mode.

Example:

Figure 3-14 shows an example using the HOLD stop level mode with a 30° phase setting and a sine wave. The output during the stop mode is at the same level as the 30° phase point (at half the waveform peak level for a sine wave).

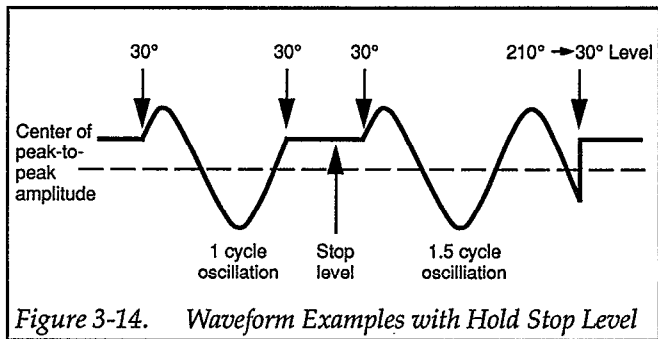

Figure 3-14. Waveform Examples with Hold Stop Level

Example:

Figure 3-15 shows an example of the RESET stop level mode. Conditions for this waveform are: Stop level: RESET; waveform: sine wave; phase: 90° ; amplitude: 2V p-p; offset voltage: 0V. The output level during the waveform stop mode will be at center value of $\pm 1V$ (2V p-p) value, or 0V. Since the oscillation start phase is 90° , the output level will rapidly change from 0V to 1V (the voltage at the 90° point) at the start of the oscillation phase. Since the oscillation phase ends at 90° or 270° , at which point the oscillation stop mode begins, the output will rapidly change from 1V or $-1V$ to the 0V stop level, and will maintain that 0V value until the next oscillation phase begins.

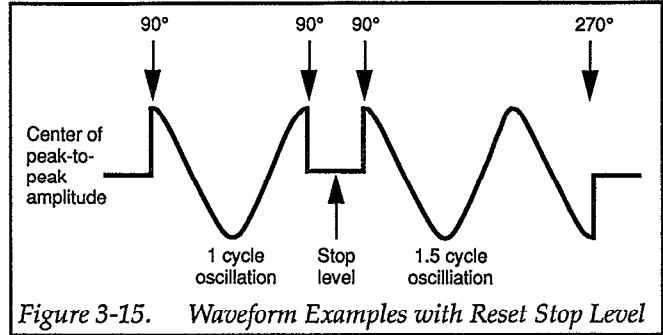

Figure 3-15. Waveform Examples with Reset Stop Level

ϕ SYNC

Pressing SHIFT ϕ SYNC enters the phase sync mode and generates the phase sync pulse. The purpose of the phase sync pulse is to restart the waveform from the set phase value.

Phase sync operation is guaranteed only for the continuous oscillation mode of the main synthesizer. Phase sync can be used to synchronize master and slave synthesizer phases when using two Model 3940s synchronously, and it can also be used to internally synchronize main synthesizer and sub synthesizer phases.

Example:

Figure 3-16 demonstrates phase sync operation between the main and sub synthesizers. The main synthesizer frequency is 1kHz and its phase is 0° ; the sub synthesizer phase setting is 90° . If the sub synthesizer frequency is 1kHz, which is identical to the main synthesizer frequency setting, two identical waveforms with different phase characteristics can be observed with an oscilloscope. The constant phase relationship between the two waveforms is the result of the identical 1kHz frequencies of the two signals, and, although the phase settings may differ by exactly 90° , the actual phase difference between the two signals may not necessarily be exactly 90° .

If the ϕ SYNC key is pressed at this point, both waveforms will restart at their initial phase settings (0° for the main synthesizer signal, and 90° for the sub synthesizer signal). Thus, the phase of the sub synthesizer output will be approximately 90° relative to the phase of the main synthesizer output, and accurate phase relationships between the two signals will be maintained regardless of the individual phase settings.

The time between the phase sync pulse and the restart of the waveform differs between the main synthesizer and sub synthesizer. In addition, this delay time will vary de-

pending on the waveform type. As a result, deviations in the phase relationships may be greater at higher frequencies when using phase sync. You can manually fine tune the phase settings of the two synthesizers to obtain a more accurate phase relationship. See the specifications in Appendix B (synchronous operation) for more details on delay time.

When phase relationships are more accurately defined through phase sync, the Model 3940 can be used as a two-phase oscillator with accurate phase relationships between the main and sub synthesizer signals. The phase of either synthesizer signal can be changed, and an accurate phase relationship between the two will be maintained once phase sync has been initiated.

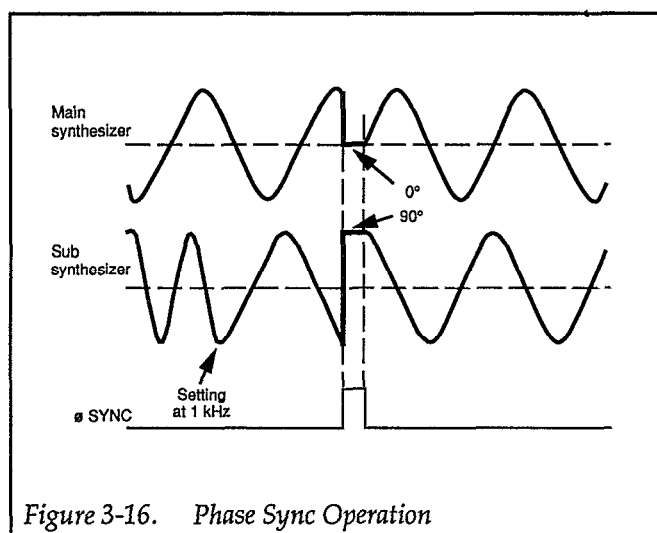

Figure 3-16. Phase Sync Operation

Example:

If the main synthesizer and sub synthesizer signals are 90° out of phase (as in the previous example), and both phase settings are changed to 0°, the phases of the two signals will be identical (0°), and the two signals will be exactly in phase. If both phases are set to 90°, the phases will again be identical (90°), and the two signals will also be exactly in phase. If the phase of either signal is set to 180°, the two signals will be out of phase.

Example:

Figure 3-17 demonstrates phase sync operation with signals at two different frequencies. Here, a phase sync operation is performed with main synthesizer frequency at 2kHz and the sub synthesizer at 1kHz. Under these conditions, the main synthesizer 0° point will correspond to the sub synthesizer 0° phase point.

If the main synthesizer phase is subsequently set to 45°, the main synthesizer 45° point will now correspond to the sub synthesizer 0° phase point. If the main synthesizer phase is set to 0° and the sub synthesizer phase is set to 45°, the main synthesizer 0° point will correspond to the sub synthesizer 45° point.

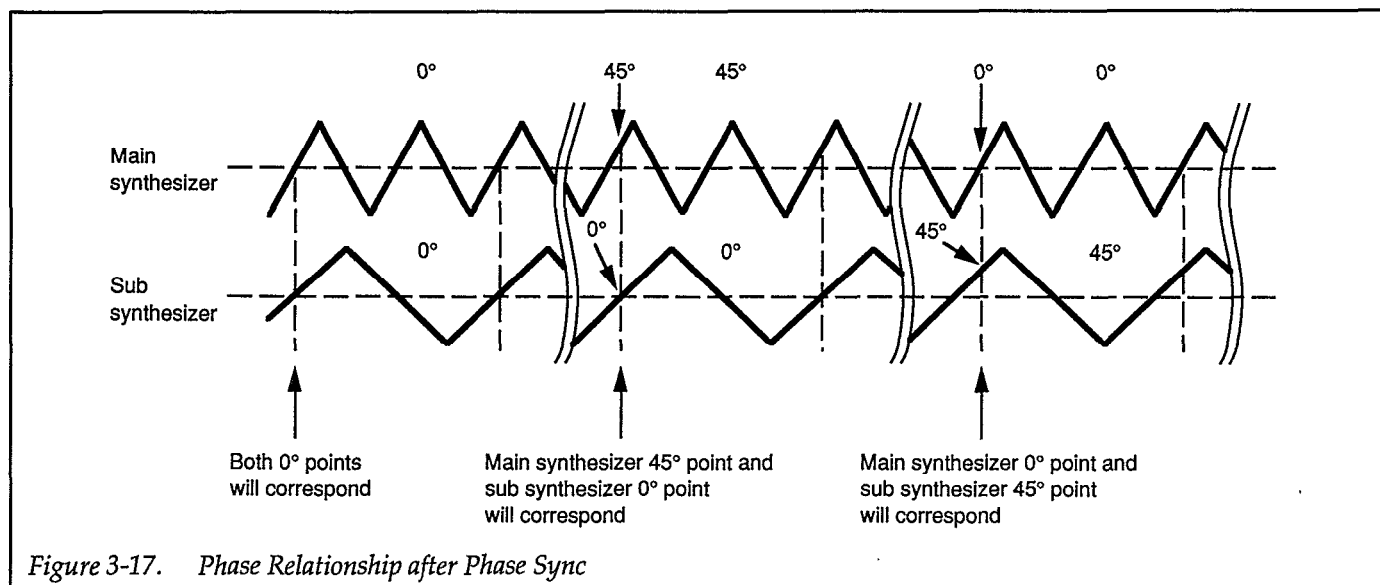

Figure 3-17. Phase Relationship after Phase Sync

3.5.13 Synchronous Operation

Multiple Model 3940s can be connected together synchronously to form a multiphase oscillator. The phase relationship between the oscillators can be accurately defined by using ϕ SYNC.

With the units turned off, connect the optional Model 3949 Synchronous Cable to the PHASE SYNC I/O connector on the rear panel of each unit. The Model 3940 with the connector labelled "MASTER" is the master unit and transmits clock and phase sync pulses to the slave unit. The Model 3940 with the connector labelled "SLAVE" is the slave unit that receives clock and phase sync pulses transmitted from the master unit. Note that slave unit ϕ SYNC key will be inoperative, and the slave unit will not respond to the GPIB "SYN" command.

After connecting the units and setting up waveforms and frequencies, press the ϕ SYNC key on the master unit to synchronize phases. You can then set the phases for the units independently, and accurate phase relationships between waveforms from the two instruments will be maintained. The ϕ SYNC phase relationships for external synchronous operation are similar to those discussed previously for main synthesizer and the sub synthesizer phases (see paragraph 3.5.12).

3.5.14 Frequency Sweep Operation

The Model 3940 can be set up to generate frequency sweeps over a variety of ranges. The following paragraphs discuss the various aspects of programming frequency sweeps. Figure 3-18 shows sweep waveforms, and Figure 3-19 details sweep operation.

Setting the Sweep Range

You can set the sweep range in one of two ways: (1) by setting the start and stop frequencies, or (2) by setting the center and span frequencies. The actual sweep is generated from the start frequency to the stop frequency, and the sweep direction is determined by the relative values of the start and stop frequencies. If the start frequency is lower than the stop frequency, an ascending-frequency sweep will be generated. If the start frequency is higher than the stop frequency, a descending-frequency sweep will be generated.

If you specify the center and span frequencies to set the sweep range, the Model 3940 will automatically convert them into start and stop frequencies. See the specifications in Appendix B for more details on the sweep range and sweep width.

The Model 3940 determines the sweep range as described below when you change a frequency parameter:

- When you change the start frequency:
The stop frequency remains unchanged.
Center frequency = $(\text{start frequency} + \text{stop frequency})/2$
(Portion of value below 0.1mHz is truncated.)
Span frequency = $|\text{start frequency} - \text{stop frequency}|$
- When you change the stop frequency:
The start frequency remains unchanged.
Center frequency = $(\text{start frequency} + \text{stop frequency})/2$
(Portion of value below 0.1mHz is truncated.)
Span frequency = $|\text{start frequency} - \text{stop frequency}|$
- When you change the center frequency:
The span frequency remains unchanged.
The relationship between the start and stop frequency values remains the same as it was before you changed the center frequency:
Start frequency = $(\text{center frequency} \mp \text{span frequency}/2)$
(Portion of value below 0.1mHz is truncated.)
Stop frequency = $(\text{center frequency} \pm \text{span frequency}/2)$
(Portion of value below 0.1mHz is truncated.)
- When you change the span frequency:
The center frequency remains unchanged.
The relationship between the start and stop frequency values remains the same as it was before you changed the span frequency:
Start frequency = $(\text{center frequency} \mp \text{span frequency}/2)$
(Part smaller than 0.1mHz is truncated.)
Stop frequency = $(\text{center frequency} \pm \text{span frequency}/2)$
(Part smaller than 0.1mHz is truncated.)

The start and stop frequencies always correspond to the opposite ends of the actual sweep range. When the span frequency is an odd number of 0.1mHz units, the displayed center frequency will be 0.05mHz lower than the actual center frequency value. The center frequency is the center frequency on the linear scale, and it is not the cen-

ter frequency based on the sweep time in the log sweep mode.

Sweep Time

Sweep time will vary depending on the selected sweep function.

- When the sweep function is \wedge :
 Sweep time = time of transition from start frequency to stop frequency
 = time of transition from stop frequency to start frequency
 = half of repetition period of continuous sweep
- When the sweep function is \nearrow :
 Sweep time = time of transition from start frequency to stop frequency
 = repetition period of continuous sweep
- When the sweep function is \sqcap :
 Sweep time = duration of start frequency in continuous sweep
 = duration of stop frequency in continuous sweep
 = half of repetition on continuous sweep

When the sweep times for the \wedge and \nearrow sweep functions are identical, the sweep rate along the equivalent sloped portions of the two waveforms will also be identical. Note, however, that the continuous-sweep repetition period for the two functions is different. See Figure 3-18 for more details on sweep progression.

Sweep Operations

Model 3940 sweep operations include the following eight types of sweeps:

- Starting a continuous sweep (CONT START key).
- Starting a single sweep (SINGL START key).
- Holding and resuming a sweep (HOLD/RESM key).
- Turning a sweep off to enable normal frequency programming (SWEEP OFF key).
- Setting the output waveform to the start frequency (START STATE key).
- Setting the output waveform to the stop frequency (STOP STATE key).
- Starting a single sweep with external signals (SINGL START IN BNC jack).
- Holding and resuming a sweep with external signals. (HOLD IN BNC jack).

Starting a Continuous Sweep

To start a continuous sweep, press SHIFT CONT START. During the sweep, the Model 3940 displays the sweep frequency, and the following message is displayed: "CONT SWEEP EXEC (EXIT:SWEEP OFF)". When the Model 3940 is in this mode, you cannot set the frequency with the FREQ key.

Starting a Single Sweep

Press the SINGL START key to initiate a single sweep. During a single sweep, the Model 3940 displays the sweep frequency, and the following message is displayed: "SINGL SWEEP EXEC (EXIT:SWEEP OFF)". You cannot set the frequency with the FREQ key while the unit is generating a single sweep.

When the Model 3940 terminates a single sweep, it displays the terminated sweep frequency along with the following message "SINGL SWEEP END". Once the sweep has terminated, you can program the output frequency with the FREQ key.

The MKR OUT and SWEEP SYNC OUT signals go high, and the X DRIVE OUT signal is set to 0V at the end of the sweep.

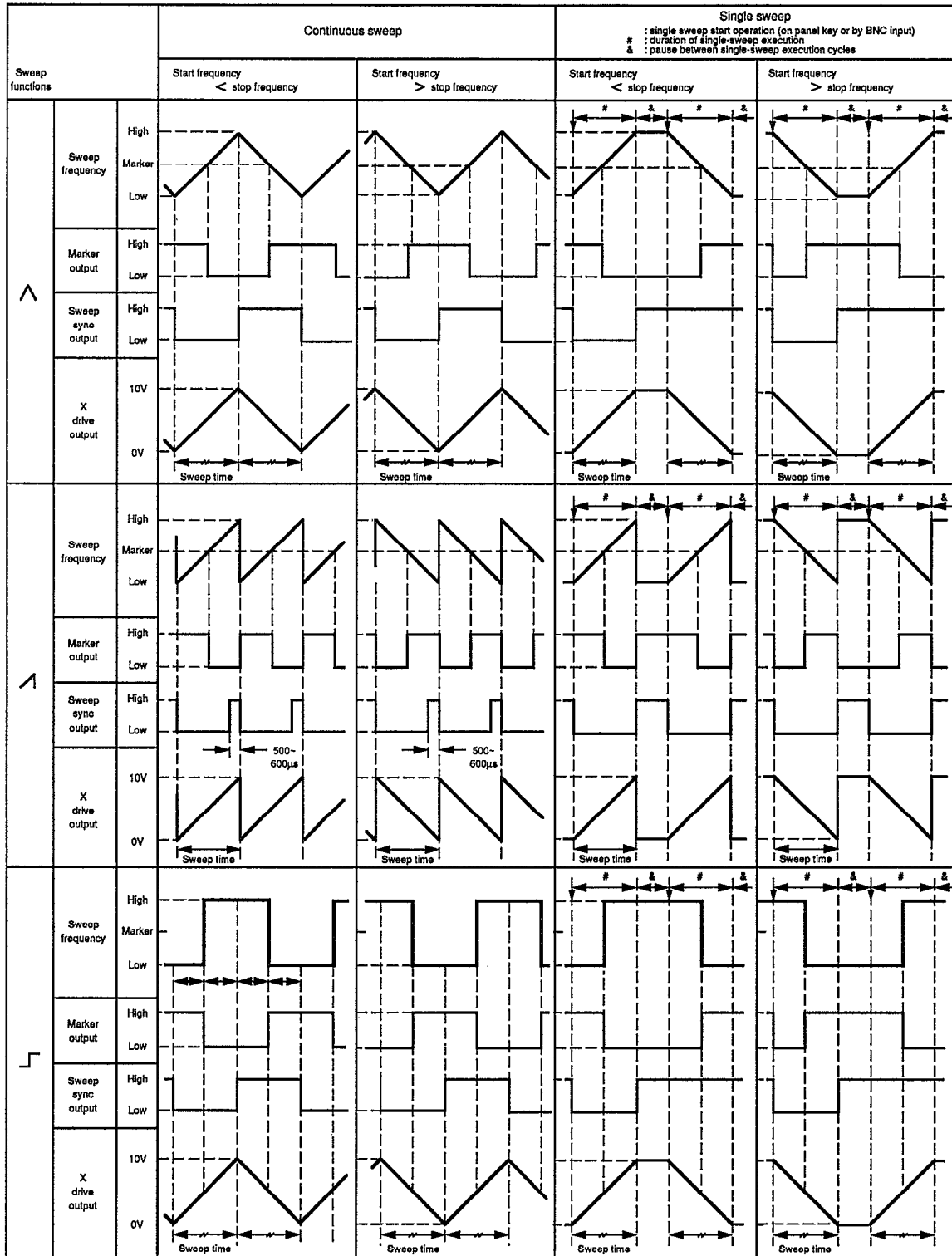

NOTE: The x-axis is the time axis, indicating increasing time toward the right.
◆ represents approximately 250µs for linear sweep, and approximately 500µs for log sweep.

Figure 3-18. Sweep Frequency and Sweep Output

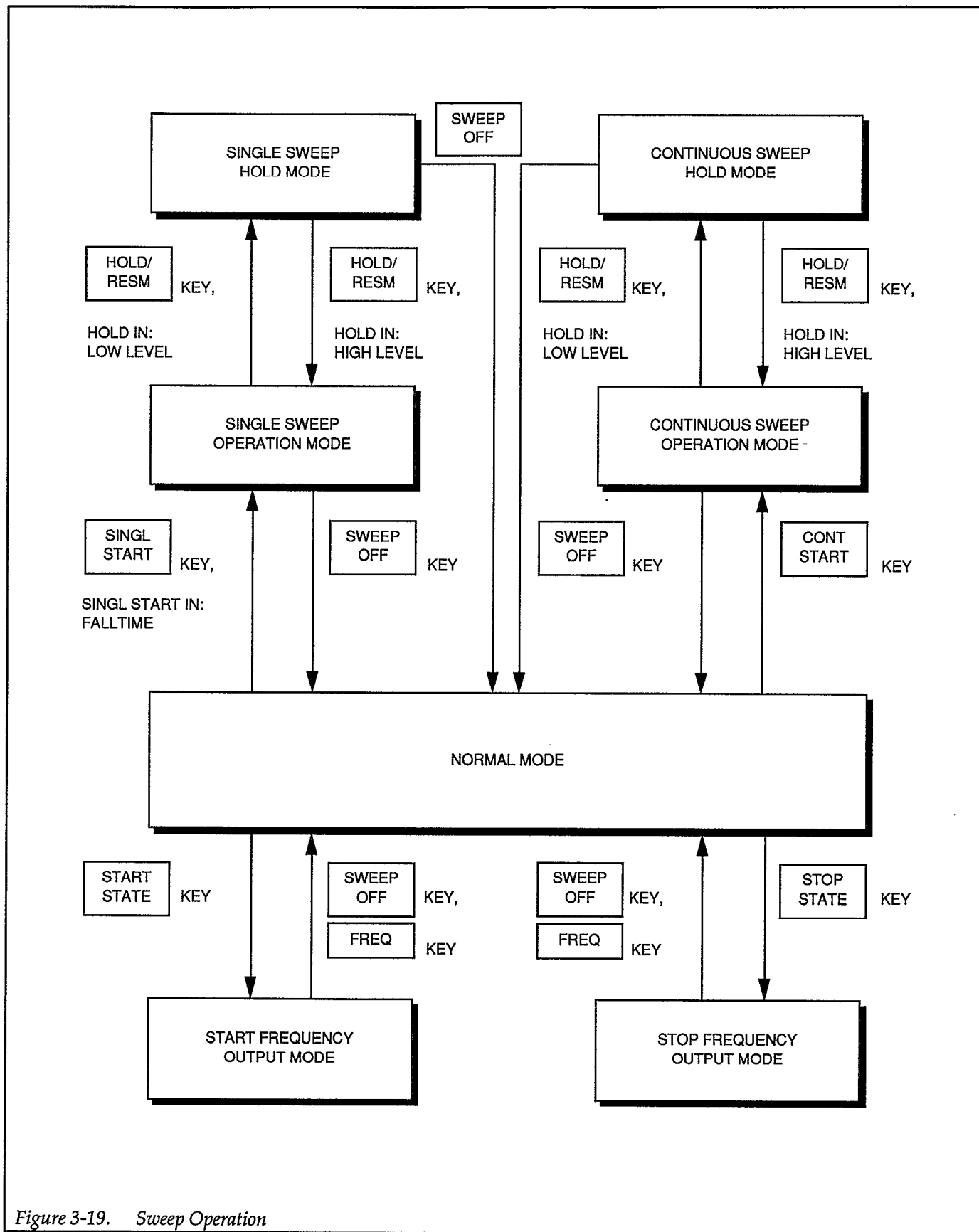

Figure 3-19. Sweep Operation

Holding/Resuming a Sweep from the Front Panel

To temporarily halt execution of a continuous or single sweep, press the HOLD/RESM key. The Model 3940 stops the sweep operation immediately, and it displays the frequency at which it stopped the sweep. The MKR OUT, SWEEP SYNC OUT, and X DRIVE OUT signals maintain their current values when the sweep is halted.

When a continuous sweep is paused, the Model 3940 displays "CONT SWEEP HOLD (EXIT:SWEEP OFF)"; similarly the unit displays "SINGL SWEEP HOLD (EXIT:SWEEP OFF)" when a single sweep is paused. When the Model 3940 is in the sweep hold mode, you cannot program the frequency with the FREQ key.

To resume a sweep starting at the frequency at which you stopped sweep operation, press the HOLD/RESM key again.

Turning a Sweep Off to Enable Normal Frequency Programming.

Press the SWEEP OFF key during a sweep or sweep hold to turn off a sweep and enable normal FREQ key programming. The MKR OUT and SWEEP SYNC OUT signals will be set high, and the X DRIVE OUT signal will be set to 0V.

When the SWEEP OFF or FREQ keys are pressed at the completion of a single sweep, during start frequency output, or during stop frequency output, normal frequency programming will be enabled. In addition, the MKR OUT and SWEEP SYNC OUT signals will be set high, and the X DRIVE OUT signal will be set to 0V.

Setting the Output to the Start Frequency

Press the START STATE key to set the output waveform to the programmed start frequency. During this mode, the Model 3940 displays the start frequency along with the following message: "SWEEP START STATE". The MKR OUT and SWEEP SYNC OUT signals also go high during the start frequency mode. The X DRIVE OUT signal is set to 0V if the start frequency is lower than the stop frequency; it is set to 10V if the start frequency is higher than the stop frequency.

When the Model 3940 is in this mode, pressing the FREQ key enables normal frequency programming with the FREQ key and sets the X DRIVE OUT signal to 0V.

Setting the Output to the Stop Frequency

Press SHIFT STOP STATE to set the output waveform to the programmed stop frequency. While in this mode, the Model 3940 displays the stop frequency along with the following message: "SWEEP STOP STATE". During the sweep stop state, the MKR OUT and SWEEP SYNC OUT signals are set high. X DRIVE OUT is set to 10V if the start frequency is lower than the stop frequency; it is set to 0V if the start frequency is higher than the stop frequency.

When the Model 3940 is in this mode, pressing the FREQ key enables normal frequency programming with the FREQ key and sets the X DRIVE OUT signal to 0V.

Starting a Single Sweep Using an External Signal

A TTL-level, falling-edge signal, applied to the SINGL START IN BNC connector, starts a single sweep. This signal performs essentially the same operation as pressing the SINGL START key.

SINGL START IN is internally pulled up to a high logic level, and sweep operation is not affected when the this connector is left disconnected from external signals.

Holding/Resuming a Sweep with an External Signal

A TTL low-level signal, applied to the SWEEP HOLD IN BNC connector, places the Model 3940 in the sweep hold mode. In the sweep execution mode, the Model 3940 halts the sweep as long as this input remains low. If you attempt to start a sweep when this input is low, the Model 3940 immediately enters the sweep hold mode. Note that pressing HOLD/RESM does not resume sweep operation with the hold signal held low; you must set SWEEP HOLD IN high to resume the sweep.

SWEEP HOLD IN is internally pulled up to a high logic level, and sweep operation is not affected when this connector is left disconnected from external signals.

Sweep Frequency and Sweep Output

Figure 3-18 illustrates how the sweep frequency and the MKR OUT, SWEEP SYNC OUT, and X DRIVE OUT signals change with time.

The MKR OUT signal is high when the sweep frequency is higher than the marker frequency. When the sweep function is \wedge or \sqcap , the high signal level is maintained even after a single sweep is terminated.

The SWEEP SYNC OUT signal goes low during the transition from the start frequency to the stop frequency. When the sweep function is \sqcap , the frequency changes at the center point of this output signal.

The X DRIVE OUT jack supplies a voltage that varies between 0V and 10V in proportion to the lapse of sweep time, and according to the direction of the sweep frequency. The X DRIVE OUT signal also varies linearly with time in the log sweep or step sweep mode.

Substituting Marker Frequency for Center Frequency

Press SHIFT CTR \blacktriangleleft to set the center frequency to the current marker frequency value. This operation produces the same result as programming an identical frequency with the numeric keys. The marker frequency is not affected by this operation.

Changing Settings During Sweep Operation

Because of processing execution time in the sweep execution mode, the Model 3940 may respond to the keys and GPIB commands more slowly than in other modes. If you change the sweep range, sweep time, or sweep function with MODIFY while the Model 3940 is in the sweep execution mode, the unit will recalculate the new parameters each time you change the setting, resulting in slower response.

If you set the sweep range based on center and span frequencies, an error may occur depending on the order of parameter selection whether or not the Model 3940 is in the sweep execution mode.

Example:

To change a 5kHz center frequency and an 8kHz span frequency to 2kHz and 3kHz respectively, you must first change the span frequency to 3kHz and then change the center frequency to 2kHz. If you first change the center frequency to 2kHz, an error will occur because this combination would result in a start frequency of -2kHz.

Number of Steps in a Sweep

Sweep operation of the Model 3940 is timed by fixed-interval interrupts, which results in accurate sweep timing with specific, accurately timed sweep steps. As a result, the actual sweep time will never exceed the actual programmed sweep time. In addition, the number of sweep steps will simply increase or decrease as sweep time is changed.

The number of steps in sweep can be calculated as outlined below.

Linear Sweep Steps

Within a linear sweep, output frequency is changed every 250 μ sec. Therefore, the number of steps can be calculated as follows:

$$\text{Number of steps: Sweep time (sec)} \times 4000$$

The number of steps represents the number of frequency changes that occur between the start frequency and the stop frequency. With the \wedge sweep function, the number of steps also represents the number of frequency changes between the stop frequency and the start frequency.

If the single-step frequency increase/decrease width is equated to the step width, the step width can be represented as follows:

$$\text{Step Width (Hz)} = \frac{\text{Sweep width (Hz)}}{\text{Number of steps} - 1}$$

The frequency resolution of the step width may not be a whole number of 0.1mHz units. As a result, the frequency-variable width of a single step is:

$$\text{Step width: } \pm 0.1\text{mHz.}$$

The MKR OUT signal is synchronous with the sweep steps. With an ascending sweep, the MKR OUT signal is low when the sweep frequency is higher than the marker frequency. With a descending sweep, the marker output is high when the sweep frequency is lower than the marker frequency. The deviation between the set marker frequency value and the actual transition in the MKR OUT signal is:

Marker Deviation (Maximum): \pm Step width (Hz)

The X DRIVE OUT signal will also change synchronously as the sweep progress. Resolution of this output signal is 10 bits.

Log Sweep Steps

With log sweeps, the output frequency is changed every 500 μ sec. Frequency update is slower in log sweep than in

linear sweep due to the calculations required for log sweeps. Consequently, the number of steps for log sweeps can be calculated as follows:

Number of steps: Sweep time (sec) \times 2000

If the single-step frequency increase/decrease multiplier is equated to the step multiplier, the step multiplier can be calculated as follows:

$$\log^{-1} \left(\log 10 \frac{\text{Stop frequency (Hz)}}{\text{Start frequency (Hz)}} + (\text{Number of steps} - 1) \right)$$

The step width (frequency) will change as the sweep progresses. The deviation between the set marker frequency and the MKR OUT signal is:

Marker Deviation (Maximum.): +Step width (Hz)

SECTION 4

GPIB OPERATION

4.1 INTRODUCTION

4.1.1 GPIB Overview

The GPIB Interface is a general-purpose interface bus system recognized by the IEEE (Institute of Electrical and Electronics Engineers) in 1975 and is a method of standardizing data transfer between measuring instruments and peripherals. By building each controller and peripheral device into an interface conforming to this standard, it is possible to establish complete hardware compatibility among devices.

Up to 15 devices may be connected to a single interface bus and data transfer is performed by three handshake lines, enabling reliable data transfer between data senders (talkers) and receivers (listeners) having differing data transfer rates.

4.1.2 Major GPIB Specifications

Overall cable length: 20m maximum

Cable lengths between devices: 4m maximum

Number of devices connectable
(including a controller): 15 maximum

Transfer method: 3-Line handshake

Transfer rate: 1M bytes/sec (maximum)

Data transfer: 8-bit parallel

Signal lines:

Data bus: 8 Lines

Control bus: 8 Lines

(including DAV, NRFD, and NDAC handshake lines and ATN, REN, IFC, SRQ, and EOI control lines)

Signal/system grounds: 8 Lines

Signal logic: Negative

True (low-level): 0.8V maximum

False (high-level): 2.0V minimum

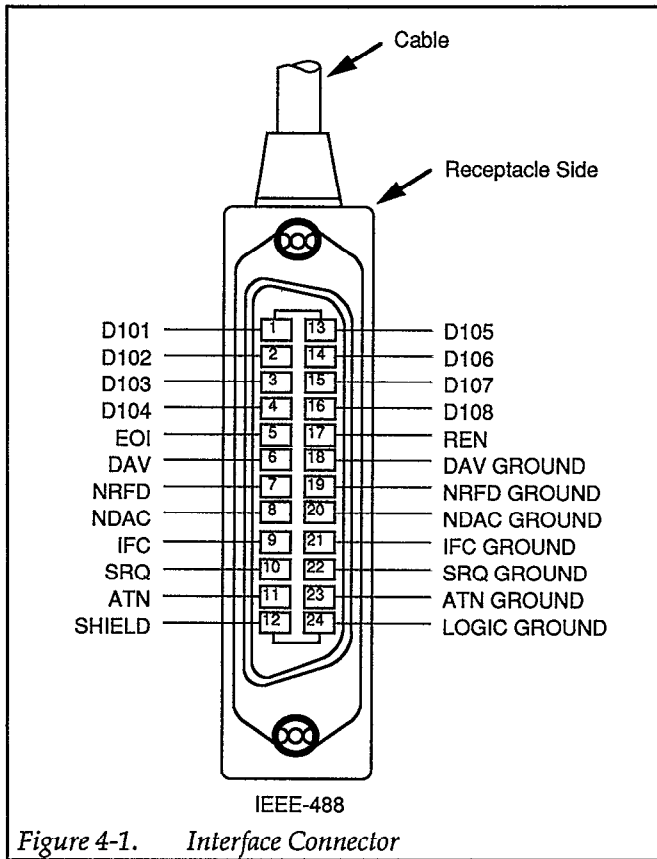

Figure 4-1. Interface Connector

4.1.3 Bus Line Signals and Operation

The GPIB bus consists of 24 lines, including eight data lines, eight control lines, and eight signal/system ground lines.

Data Bus (DIO1 to DIO8)

DIO1 through DIO8 are the data input/output lines, which are used to transfer both address and command information (the type of data present on these lines is determined by the ATN line). DIO1 is the least significant bit (LSB).

Handshake Bus (DAV, NRFD, NDAC)

These three lines are handshake lines used to ensure reliable data transfer.

DAV (DAta Valid)

This line indicates that the data on the DIO lines sent from a talker or the controller are valid.

NRFD (Not Ready For Data)

This line indicates when listeners are ready to accept data over the data lines.

NDAC (Not Data Accepted)

This line indicates the acceptance of data by listeners.

Control Bus (ATN, REN, IFC, SRQ, EOI)

ATN (ATteNtion)

This line is an output line from the controller, and it indicates whether the information on the data bus is to be interpreted as data or commands.

REN (Remote ENable)

This output line from the controller switches devices between remote control and local control.

IFC (InterFace Clear)

This output line from the controller clears the interface of active talkers and listeners.

SRQ (Service ReQuest)

This control line is used by a device to request service from the controller. The controller detects this signal and usually executes a serial or parallel poll operation.

EOI (End Or Identify)

This line is used to indicate the end of a multiple-byte transfer sequence or, in conjunction with ATN, to execute a parallel poll operation.

4.1.4 GPIB Handshaking

GPIB handshaking is performed by checking the status of all the listeners and inhibiting the next data transfer until all listeners have completed the reception of data, so that the slowest device on the bus can perform data transfer reliably. The handshaking operations are executed by the following handshake line logic levels.

NRFD = High level: All listeners are ready for accepting data.

DAV = Low level: A talker has valid data on the data bus.

NDAC = High level: All listeners have completed data reception.

The handshaking timing diagram is in Figure 4-2. The various timing points indicate the following:

- ① Indicates that all listeners are waiting for data.
- ② The talker places the data byte to be sent on the data lines. Output may have already occurred.
- ③ The talker checks NRFD, and, if high, DAV is set low to indicate to the listener that data is valid.
- ④ When DAV goes low, the listener reads data, and NRFD is set low, indicating to the talker that data processing is in progress. Each listener sets NDAC high at the completion of data input. The NDAC logic level is the result of ORing the NDAC signals from each listener.
- ⑤ When all listeners have completed receiving data, NDAC goes high, indicating to the talker that data reception has been completed.
- ⑥ The talker sets DAV high, indicating to the listener that data on the bus is no longer valid.
- ⑦ The listener checks to see whether DAV is high and sets NDAC low, completing the handshake.

- ⑧ Indicates that all listeners have completed data input, and the bus is ready to transfer the next data byte.

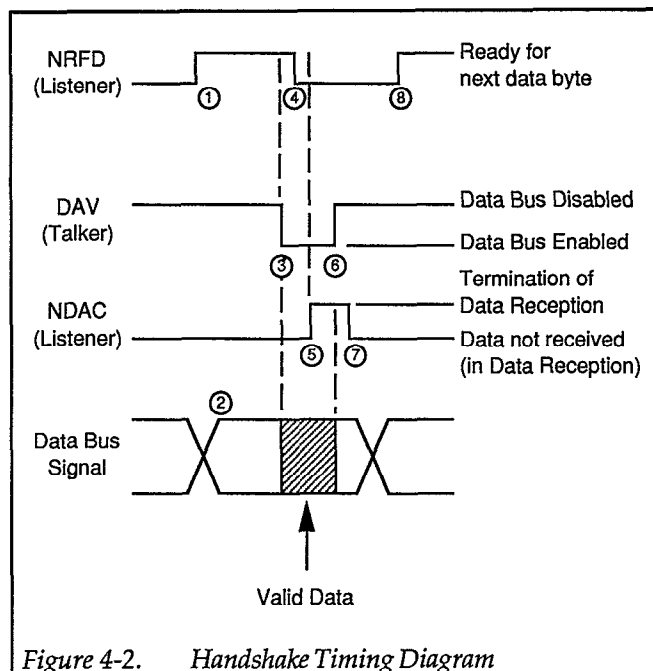

Figure 4-2. Handshake Timing Diagram

4.1.5 Data Transfer Example

Figure 4-3 shows a data transfer example using the three-line handshake process. In this example, the character string "ABC" is sent, followed by the <CR> <LF> delimiter.

4.1.6 Basic Talker Functions

- Only one talker may exist on the GPIB at a time.
- Data is sent to listeners when the controller ATN line is high (false).
- Source handshaking is performed automatically.
- A service request (SRQ) is sent to the controller by other devices.
- The talker function is available with both the local and remote modes.
- The talker function is canceled by any of the following:
 - When the talk address of another device is received.
 - When the device is addressed as a listener.
 - When the untalk (UNT) command is received.
 - When the interface clear (IFC) command is received.

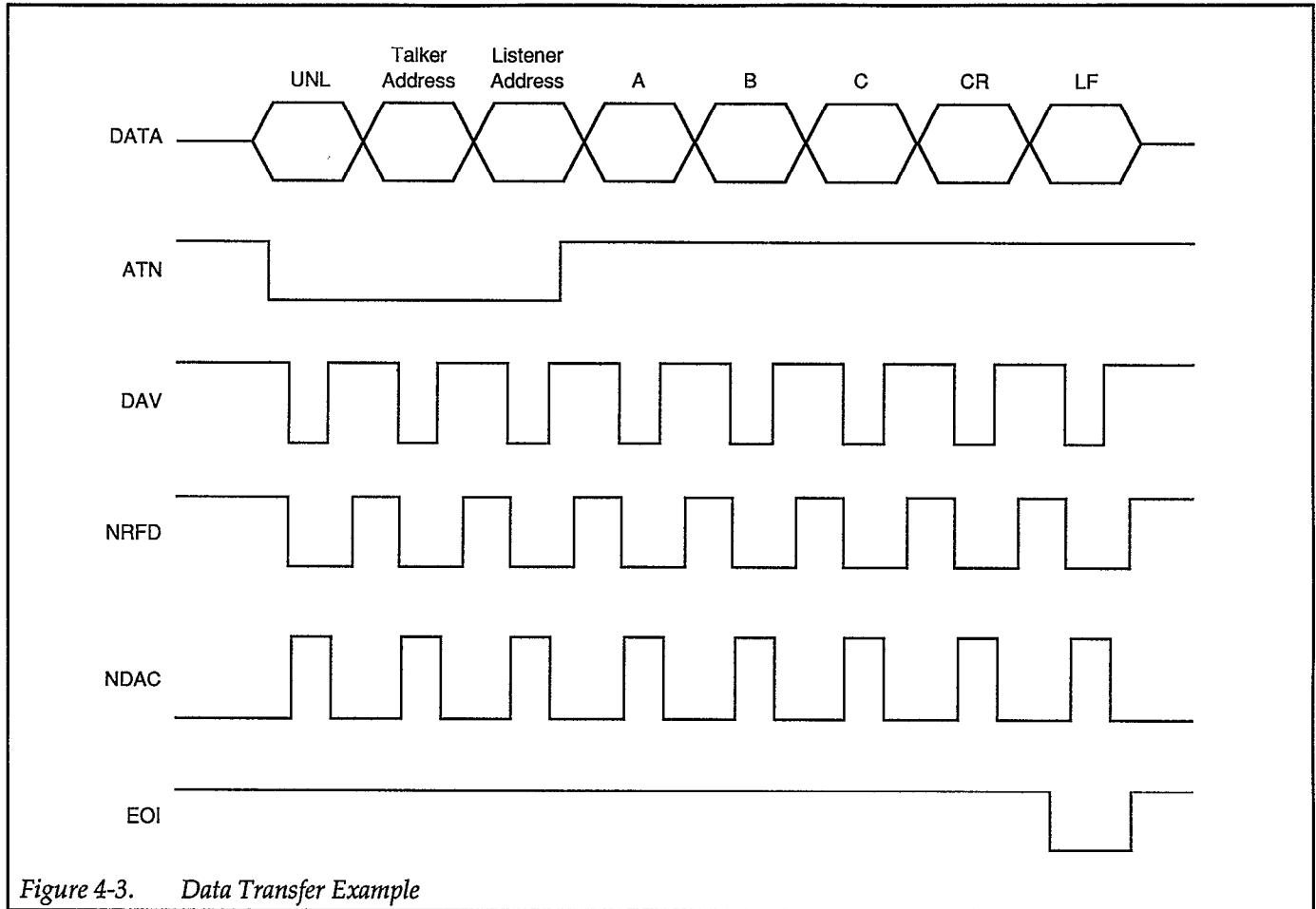

Figure 4-3. Data Transfer Example

4.1.7 Basic Listener Functions

- Two or more listeners may exist on the GPIB at any time.
- Data is received from a talker when the controller ATN signal is high.
- The acceptor handshake is performed automatically.
- The listener function is canceled by any of the following:
 - When the device is addressed to talk.
 - When the unlisten (UNL) command is received.
 - When the IFC command is received.

4.1.8 Basic Controller Functions

- Only one controller can be active on the GPIB.

- The controller sets the ATN signal to low to address devices to listen and talk, and to transmit commands such as DCL.
- The controller sends single-line commands such as IFC and REN.

4.1.9 Multi-Line Interface Messages

A multi-line interface message is sent over the data lines with ATN set low.

Table 4-1 summarizes these messages.

Table 4-1. Multi-Line Interface Messages

Column	Row	b7	b6	b5	b4	b3	b2	b1
0	0	0	0	0	0	0	0	0
1	MSG	1	0	0	0	0	0	0
2	MSG	0	1	0	0	0	0	0
3	MSG	0	0	1	0	0	0	0
4	MSG	1	0	0	0	0	0	0
5	MSG	1	0	1	0	0	0	0
6	MSG	1	1	0	0	0	0	0
7	MSG	1	1	1	0	0	0	0
8	MSG	0	0	0	0	0	0	0
9	MSG	0	0	0	0	0	0	0
10	MSG	0	0	0	0	0	0	0
11	MSG	0	0	0	0	0	0	0
12	MSG	0	0	0	0	0	0	0
13	MSG	0	0	0	0	0	0	0
14	MSG	0	0	0	0	0	0	0
15	MSG	0	0	0	0	0	0	0

- NOTES
- 1 MSG IS THE INTERFACE MESSAGE
 - 2 b1 = DIO8... b2 = DIO7
DIO8 IS NOT USED
 - 3 HAS SECONDARY COMMAND

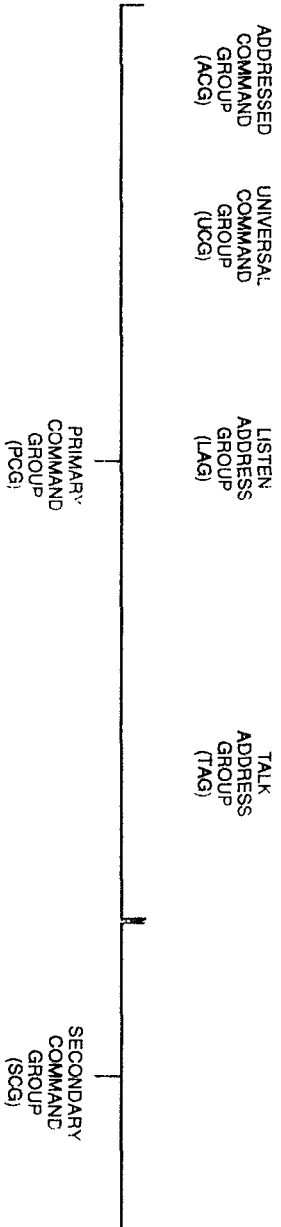

4.2 OVERVIEW OF MODEL 3940 GPIB INTERFACE

4.2.1 Introduction

The Model 3940 GPIB interface has a wide variety of interface functions. These functions allow remote the setting of most of the parameters which can be set from the front panel. The interface can also transfer setting data and conditions to an external device, enabling the user to easily configure a sophisticated, automatic measurement system.

Setting data and conditions are sent to the controller as character strings in ASCII format.

4.2.2 Specifications

Interface Functions

Table 4-2 shows the interface functions of the Model 3940.

Bus Driver

Table 4-3 gives the bus driver specifications.

Table 4-3. Bus Driver Specifications

DIO1 to DIO8 NDAC, NRFD, SRQ	Open Collector
DAV EOI	3 state

Codes

Codes which can be received by the Model 3940 in listener mode are in 7-bit ASCII format (bit 7 is ignored). Codes can be sent using either lower-case or upper-case letters. In either case, codes are interpreted and executed identically. The space (20H), tab (09H), null (00H), and semicolon ";" (3BH) are ignored.

Talker mode transmission codes are also in 7-bit ASCII format. All letter characters are sent as upper-case letters.

GPIB Primary Address

The GPIB address of the Model 3940 is set by the front panel GPIB key. Set values are stored in battery backed up memory when the power is turned off. For details on setting the primary address, in paragraph 3.2.1.

The factory default value for the primary address is 2.

Table 4-2. Interface Functions

Function	Subset	Explanation
Source Handshake	SH1	Full source handshaking capability
Acceptor Handshake	AH1	Full acceptor handshaking capability
Talker	T6	Basic talker, serial poll, talker unaddresses on MLA
Listener	L4	Basic listener, unaddresses on MTA
Service Request	SR1	Full service request capability
Remote/Local	RL1	Full remote and local operation capability
Parallel Poll	PP0	No parallel-polling capability
Device Clear	DC1	Full device clear capability
Device Trigger	DT0	No device trigger function capability
Controller	C0	No controller function capability

Delimiter

The Model 3940 recognizes <CR>, <LF>, or <EOI> in any combination as a delimiter for receiving code strings in the listener mode.

The delimiter use when sending a code string in the talker mode is set from the front panel with the GPIB key. Only <CR> or <CR><LF> can be selected as an output delimiter, and EOI is sent simultaneously. For information on delimiter selection, in paragraph 3.2.1. The factory default delimiter is <CR><LF> ^ EOI.

Response to Interface Messages

Table 4-4 summarizes Model 3940 responses to interface messages.

Table 4-4. Responses to Interface Messages

IFC	Initializes GPIB interface Releases specified listener and talker modes.
DCL and SDC	Clears GPIB input/output buffer. Clears error status. Releases SRQ issuance and resets SRQ causes (function of main unit remains unchanged).
LLO	Disables front panel LOCAL key.
GTL	Sets local mode.

Program Codes

Program codes used for the various settings of the Model 3940 are temporarily stored in the input buffer as received. When a delimiter is received, they are interpreted and executed in the order received. The input buffer can store up to 256 characters (256 bytes). Note that space, tab, null, semicolon, and delimiter characters are not stored in the input buffer.

When a more than 256 program code characters are received, the input buffer overflows. When an overflow occurs, the input buffer is cleared, and program codes stored in the buffer are not executed.

In addition, the input buffer is cleared when a GPIB error occurs, and subsequent program codes are not executed

when an illegal header or parameter is found during the interpretation of a program code. The input buffer is similarly cleared and subsequent program codes are not executed when errors other than the above occur during the interpretation of a program code.

When interpretation and execution are completed, the input buffer is cleared, and the unit is ready to receive the next program code.

As shown in Figure 4-4, program codes consists of a header and a parameter. More than one program code can be sent at a time, up to a maximum of 256 characters. Multiple program codes can be separated by a space or semicolon (;) to improve readability.

There are two general types of program codes: parameter-setting messages and inquiry messages. Parameter-setting messages are used for setting parameters or for sending operating instructions. Inquiry messages are used for requesting instrument state and parameter setting information.

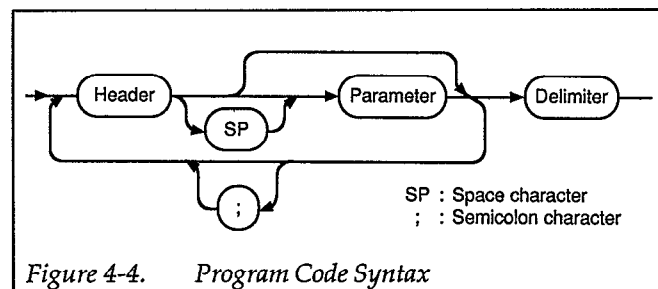

Parameter Setting Messages

The format of a basic setting message is shown below. In this example, the frequency is set to 1.0kHz, and the amplitude is set to 1.0Vp-p/no load.

FRO 1.0E+03 AMV 1.0E+00
 a b c d e f g h i j

- a: Indicates the three-letter alphabetic character header. Either upper-case or lower-case letters can be used.
- b: Indicates a space character inserted for readability. There is no limit on the number of spaces, and the space can be omitted. Space, tab, null, and semicolon characters are ignored and are not stored in the GPIB input buffer.

- c: Indicates the parameter mantissa. The mantissa includes a polarity sign (space for +, or -), numeric value, and decimal point. When the polarity sign is omitted, the plus sign (+) is assumed. Parameters are described in detail in the following paragraph.
- d: Indicates the exponent. Depending on the type of program code, an exponent may not be included with the parameter.
- e: Indicates the semicolon used to separate program codes for readability. There is no limit on the number of semicolons, and the semicolon can be omitted. The semicolon is also ignored and is not stored in the GPIB input buffer.

Numeric Format of Parameter-setting Messages

The three formats described below are used for the various parameter-setting messages.

NR1 Format

In the NR1 format, numeric values are specified as integers. No decimal point is used in this format. The decimal point is assumed to be at the end of the last character.

±DDDD

- Leading zeroes and spaces are ignored
- Sign (+ for positive, - for negative; + is assumed if sign is omitted).

Examples: +01234
 -500
 18

NR2 Format

In the NR2 format, numeric values are specified as real numbers. NR2 numeric values include a decimal point, but digits to the right of the decimal point can be omitted.

±DD.DD

- Leading zeroes and spaces are ignored
- Sign (+ for positive, - for negative, + is assumed if sign is omitted).

Examples: +012.34
 -50.0
 1.8

NR3 Format

In the NR3 format, numeric values are specified in exponential form. The exponent character, E, and subsequent sign and numbers can be omitted. When the exponent is omitted, E+00 is assumed, and the value is handled as an NR2 format parameter.

±DD.DD E±DD

- Leading zeroes and spaces are ignored
- Sign (+ for positive, - for negative, + is assumed if sign is omitted).
- Same as NR2 format.

Examples: +012.34E+03
 -50.0E-06
 1.8E-09

Inquiry Messages

An inquiry message is a special program code with a question mark (?) located at the beginning. An inquiry message is used to request information from the instrument regarding a state or particular parameter setting.

Except for special cases, each inquiry message corresponds to an equivalent parameter-setting message. Inquiry messages include only the header and a question mark; no parameters are used.

After receiving an inquiry message, the Model 3940 searches for the corresponding setting and places the response in its output buffer. When it is addressed to talk, it sends that setting information to the controller.

The response output format is the same as the format of the corresponding setting message, as shown in Figure 4-5. The format for inquiries without corresponding messages are discussed below.

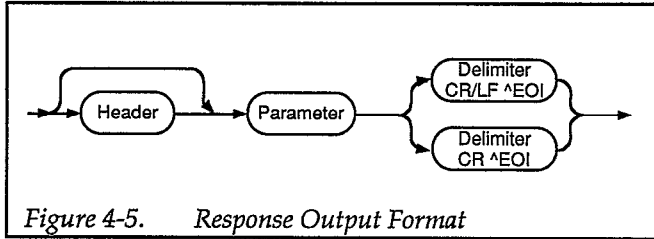

Figure 4-5. Response Output Format

When more than one inquiry is sent to the Model 3940 at the same time, only the last request is accepted, and previous requests are ignored. When a new inquiry is received before the response for a previous request is completed, the new request over-rides the previous request.

NOTES:

1. The header in the inquiry response string can be turned on or off by sending the command "HDR 1" or "HDR 0" respectively. The power-on default header state is header on("HDR 1").
2. Either <CR><LF>^EOI or <CR>^EOI can be selected as the inquiry response delimiter. The delimiter can be programmed with the front panel GPIB key; see paragraph 3.2.1. The factory default delimiter is <CR><LF>^EOI.

Numeric Format of Inquiry Message Response Parameters

As described below, three different formats are used for inquiry response parameters.

NR1 Inquiry Response Format

- DDDD
- Numeric digits.
 - Space indicates plus sign is assumed.
 - The plus sign is assumed for all NR1 format values except for the ARB format readout.
 - Same as NR2 format.

Example: FNC 1

(Indicates the output waveform is . Header: three characters, space indicating sign: one character, numeric parameter: one character. Total: five characters.)

NR2 Inquiry Response Format

In the NR2 format, inquiry response parameters are specified as real numbers:

- DD.DD
- Numeric digits with decimal point
 - Space represents plus, and minus sign (-) indicates negative values.
 - The decimal point is always included.
 - The number of parameter characters for each information item is fixed.

Example: DTY 25.0

(Indicates that the square-wave duty cycle is set to 25%. Header: three characters, space indicating sign: one character, numeric parameter including decimal point: four characters. Total: eight characters.)

NR3 Inquiry Response Format

In the NR3 format, parameters are specified in exponential form:

- DD.DD E±DD
- Exponent (value is a multiple of 3).
 - Value includes "E" character, sign, and a two-digit value, for a total of four characters.
 - Mantissa
 - Decimal point is adjusted so that the exponent is a multiple of 3.
 - Space indicates positive value, minus sign indicates negative value.
 - Decimal point is always included
 - Number of parameter characters for each information item are fixed.

Example: STM 1.000E+00

(Indicates a one-second sweep time. Header: three characters, space indicating sign: one character, mantissa including decimal point: five characters, exponent: four characters. Total: 13 characters.)

ARB Waveform Write and Readout Operations

The ARB (arbitrary) waveform is defined by writing data values between -511 and +511 into Model 3940 address

memory locations 0 to 1023. Address locations 0 through 1023 correspond to one waveform period, while data values -511 through +511 define the waveform amplitude (-511 corresponds to the negative peak value, and +511 represents the positive peak value of the waveform).

Waveform write and readout operations can both be performed using either ASCII or binary formats. Each of these formats is discussed in the following paragraphs.

Waveform Write, ASCII Format

This format represents the various data elements as ASCII numbers using the NR1 format. Data elements are separated by commas (,).

When writing long data blocks, do not exceed 256 characters (256 bytes). The waveform-programming process is not affected by inserting the delimiter sequence during data write, but it is necessary to insert the delimiter after the programmed number of data characters have been sent.

Example:

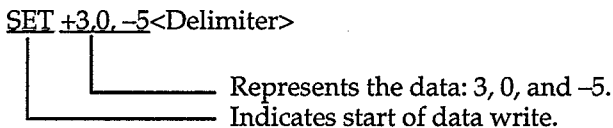
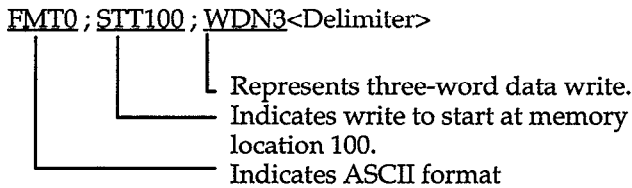

Waveform Write, Binary Format

The binary format represents the various data elements as words of data, each of which is made up of two bytes in 2s complement format. Each data word is represented in high-byte, low-byte order.

When a sequence of delimited program code that includes the "SET" command is received, the Model 3940 interprets subsequently bytes as binary data representing waveform amplitude. The number of data words is determined by the "WDN" command.

EOI will be ignored if asserted during the binary format data write except on the last byte of binary data sent.

Example:

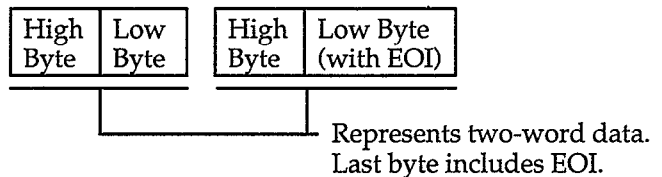
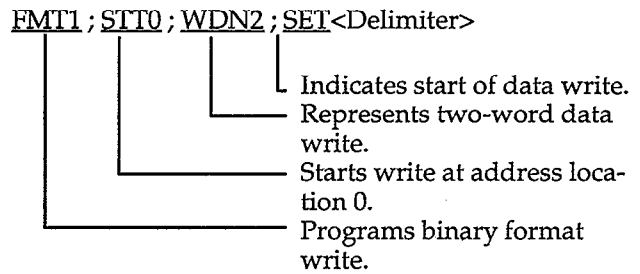

Waveform Readout, ASCII format

The ASCII waveform readout format allows you read back ARB waveform data as ASCII values. Waveform data is sent back as four-character ASCII numbers (" " or space, with three-character numbers), and is an identical format to the NR1 inquiry response format. Individual data elements are separated with commas (,).

The delimiter will be sent after each programmed block of data is sent. The number of data elements per block is specified with the "BLK" command.

The 256-character limitation that applies to ASCII waveform write operations does not apply to ASCII waveform readout. The number of data elements specified with the "DWN" command can be transmitted in one contiguous block.

Example:

FMT0 ; STT100 ; DWN3 ; BLK2 ; OUT<Delimiter>

Programs data output
 Specifies delimiter insertion.
 Sets output to three data elements.

Typical Response: -001, -000<Delimiter>
 -002<Delimiter>

Waveform Readout, Binary Format

This format allows you to read back waveform data in binary format, which is represented as two-byte words in 2s complement format. Data are transmitted in high-byte, low-byte order, and EOI is asserted with the last byte of data.

Example:

FMT1 ; STT100 ; DWN2 ; OUT<Delimiter>

Specifies start of data output.

Model 3940 Response:

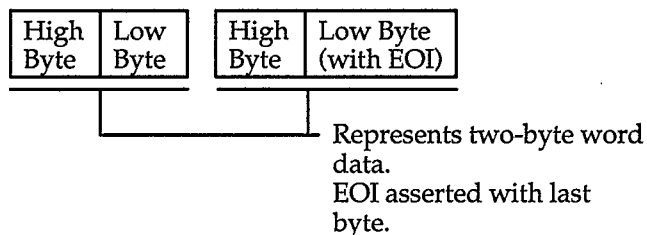

Service Request (SRQ)

The Model 3940 can request service from the controller via the SRQ line under the following conditions:

- An error conditions occurs
- A sweep stops
- A sweep starts
- Upon completion of calibration

When the controller detects an SRQ from the Model 3940 and performs a serial poll, the Model 3940 transfers the status byte and clears the SRQ signal line (set high). Table 4-5 summarizes status byte conditions.

The status byte can be read using serial polling or by sending "?STS". When the status byte is read, the following bits are reset (cleared): bit 6 (RQS), bit 5 (error), bit 2 (SWEEP stop), bit 1 (SWEEP start), and bit 0 (Calibration). Note, however, that corresponding masked SRQ bits cannot be reset.

Bits in the status byte can be masked so that those particular conditions will not cause an SRQ to occur. To mask bits, set the corresponding bits to 1 by adding up the decimal bit values and sending them with the "MSK" program code. For instance, to disable SRQ by masking the SWEEP stop (bit 2), SWEEP start (bit 1), and Calibration (bit 0), send the command "MSK 7" ($2^2 + 2^1 + 2^0 = 7$). When these bits are masked, an SRQ will not occur at sweep stop or sweep start, or during calibration.

Bit 7 (unused), bit 4 (HOLD), and bit 3 (SWEEP in execution) cannot cause an SRQ. Therefore, setting or resetting these bits has no effect on SRQ generation.

If SRQ is not masked, an SRQ is generated even when the unit is in the LOCAL mode. At power-on, all SRQ conditions are masked (MSK 63). In addition, all SRQ causes will be masked when DCL or SDC is received.

Table 4-5. Status Byte

Bit	Description	Set (1) Condition	Reset (0) Condition
(MSB) 7	0	(Unused, therefore always 0)	(Unused, therefore always 0)
6	RQS	<ul style="list-style-type: none"> When SRQ is issued 	<ul style="list-style-type: none"> When status byte is requested with SRQ mask reset condition. When DCL or SDC is received When SRQ cause is cancelled by setting SRQ mask
5	Error (SRQ cause)	<ul style="list-style-type: none"> When an error occurs 	<ul style="list-style-type: none"> When error code is requested with "?ERR" When status byte is requested with SRQ mask reset condition When DCL or SDC is received
4	HOLD	<ul style="list-style-type: none"> When sweep is stopped by "HOLD" 	<ul style="list-style-type: none"> When sweep is restarted by releasing "HOLD" When sweep is started during HOLD When sweep is turned off
3	SWEEP in execution	<ul style="list-style-type: none"> When sweep is started by sweep start When sweep is restarted by releasing "HOLD" 	<ul style="list-style-type: none"> When sweep is stopped due to the end of single sweep or sweep off When sweep is stopped by HOLD
2	SWEEP stop (SRQ cause)	<ul style="list-style-type: none"> When sweep is stopped due to the end of single sweep or sweep off When sweep is stopped by "HOLD" 	<ul style="list-style-type: none"> When status byte is requested with SRQ mask reset condition When DCL or SDC is received
1	SWEEP start (SRQ cause)	<ul style="list-style-type: none"> When sweep is started by sweep start When sweep is restarted by releasing "HOLD" 	<ul style="list-style-type: none"> When status byte is requested with SRQ mask reset condition When DCL or SDC is received
(LSB) 0	Calibration (SRQ cause)	<ul style="list-style-type: none"> When calibration is completed or stopped 	<ul style="list-style-type: none"> When status byte is requested with SRQ mask reset condition When DCL or SDC is received

Error Codes

Error codes indicate what kind of error has occurred. As each error occurs, an error code is updated, and the latest error information is always available. Error codes can be read by sending the "?ERR" inquiry. An error code is cleared when read and when a DCL or SDC command is received.

The status byte error bit (bit 5) is reset (0) when an error code cleared. When an attempt is made to read an error code by sending "?ERR" after the code is cleared,

"ERR00" is returned to indicate that the error code has been cleared.

Other returned error codes give the same information as the corresponding display error codes, which are covered in paragraph 3.5.3 in Section 3.

4.3 MODEL 3940 PROGRAM CODES

4.3.1 Model 3940 Parameter-Setting Messages

Table 4-6. Main Synthesizer Parameter Setting Messages

Function	Program Code		Operation and Setting Range	Inquiry
	Header	Parameter		
FREQUENCY	FRQ	NR3	Oscillation frequency setting (frequency: Hz) Range: 0 (0Hz) to 25.0E+06 (25MHz) Resolution: 0.1E-03 (0.1mHz) Example: FRQ 1.0E + 2 (100Hz)	Yes
PERIOD	PRD	NR3	Sets oscillation frequency by period (period: s) Range: 40.0E-09 (0Hz) (40ns=25MHz) to 10.0E+03 (10000s=0.1mHz) Resolution: 1E-09 (1ns) Example: PRD 1.0E + 00 (1s=1HZ)	Yes
AMPLITUDE Vp-p/OPEN	AMV	NR3	Sets output amplitude (Vp-p/no load) Range: 2.00E-03 (2mVp-p/no load) to 20.0E+00 (20Vp-p/no load) Resolution: 0.01mVp-p/no load Example: AMV 2.0E 0 (2Vp-p/no load)	Yes
AMPLITUDE TERMINATE Vp-p/50Ω	ATV	NR3	Sets output amplitude (Vp-p/50Ω) Range: 1.00E-03 (1mVp-p/50Ω) to 10.0E+00 (10Vp-p/50Ω) Resolution: 0.01mVp-p/50Ω Example: ATV 1E + 0 (1Vp-p/50Ω)	Yes

Main Synthesizer Parameter Setting Messages (Cont.)

Function	Program Code		Operation and Setting Range	Inquiry
	Header	Parameter		
AMPLITUDE V _{rms} /OPEN	AMR	NR3	Sets output amplitude (V _{rms} /no load) Range: For \sim : 0.71E-03 (0.71mV _{rms} /no load) to 7.07E+00 (7.07V _{rms} /no load) For \sphericalangle , \sphericalangle , \sphericalangle : 0.58E-03 (0.58mV _{rms} /no load) to 5.77E+00 (5.77V _{rms} /no load) For \sqcap : 1.00E-03 (1.00nV _{rms} /no load) to 10.0E+00 (10.0V _{rms} /no load) Resolution: 0.01mV _{rms} /no load Example: AMR 6.2E+0 (6.2V _{rms} /no load)	Yes
AMPLITUDE TERMINATE V _{rms} /50Ω	ATR	NR3	Sets output amplitude (V _{rms} /50Ω) Range: For \sim : 0.36E-03 (0.36mV _{rms} /50Ω) to 3.53E+00 (3.53V _{rms} /50Ω) For \sphericalangle , \sphericalangle , \sphericalangle : 0.29E-03 (0.29mV _{rms} /50Ω) to 2.88E+00 (2.88V _{rms} /50Ω) For \sqcap : 0.50E-03 (0.50mV _{rms} /50Ω) to 5.00E+00 (5.00V _{rms} /50Ω) Resolution: 0.01mV _{rms} /50Ω Example: ATR 3.10E+00 (3.1V _{rms} /50Ω)	Yes
AMPLITUDE dBV/OPEN	AMD	NR3	Sets output amplitude (dBV/no load) Range: For \sim : -63.0E+00 (-63.0dBV/no load) to 16.9E+00 (16.9dBV/no load) For \sphericalangle , \sphericalangle , \sphericalangle : -64.7E+00 (-64.7dBV/no load) to 15.2E+00 (15.2dBV/no load) For \sqcap : -60.0E-00 (-60.0dBV/no load) to 20.0E+00 (20.0dBV/no load) Resolution: 0.1dBV/no load Example: AMD -6.2E+00 (-6.2dBV/no load)	Yes
AMPLITUDE TERMINATE dBV/50Ω	ATD	NR3	Sets output amplitude (dBV/50Ω) Range: For \sim : -69.0E+00 (-69.0dBV/50Ω) to 10.9E+00 (10.9dBV/50Ω) For \sphericalangle , \sphericalangle , \sphericalangle : -70.7E+00 (-70.7dBV/50Ω) to 9.2E+00 (9.2dBV/50Ω) For \sqcap : -66.0E+00 (-66.0dBV/50Ω) to 13.9E+00 (13.9dBV/50Ω) Resolution: 0.1dBV/50Ω Example: ATD -10.2 (-10.2dBV/50Ω)	Yes

Main Synthesizer Parameter Setting Messages (Cont.)











Function	Program Code		Operation and Setting Range	Inquiry
	Header	Parameter		
<u>AMPLITUDE TERMINATE</u> dBm/50Ω	ATM	NR3	Sets output amplitude (dBm/50Ω) Range: For  : -56.0E+00 (-56.0dBm/50Ω) to 23.9E+00 (23.9dBm/50Ω) For  ,  ,  : -57.8E+00 (-57.8dBm/50Ω) to 22.2E+00 (22.2dBm/50Ω) For  : -53.0E+00 (-53.0dBm/50Ω) to 26.9E+00 (26.9dBm/50Ω) Resolution: 0.1dBm/50Ω Example: ATM 0.2E+00 (0.2dBm/50Ω)	Yes
<u>OFFSET</u>	OFS	NR3	Sets DC offset voltage (V/no load) Range: -10.0E+00 (-10V/no load) to 10.0E+00 (10V/no load) Resolution: 0.01mV/no load Example: OFS 4.5E-1 (0.45V/no load)	Yes
<u>OFFSET TERMINATE</u>	OFT	NR3	Sets DC offset voltage (V/50Ω) Range: -5.00E+00 (-5V/50Ω) to 5.00E+00 (5V/50Ω) Resolution: 0.01mV/50Ω Example: OFT 0.25 (0.25V/50Ω)	Yes
<u>FUNCTION</u>	FNC	NR1	Selects output waveform Range: 0 to 6 0: DC 1:  2:  3:  4:  5:  6: ARB Example: FNC 1 ()	Yes
<u>MODE</u>	MOD	NR1	Sets oscillation mode Range: 0 to 3 0: CONT (Continuous) 1: BRST (Burst) 2: TRIG (Trigger) 3: GATE Example: MOD 0 (CONT)	Yes

Table 4-7. Sub Synthesizer Parameter Setting Messages

Function	Program Code		Operation and Setting Range	Inquiry
	Header	Parameter		
<u>S</u> UB SYNTHESIZER <u>F</u> REQUENCY	SFR	NR3	Sub synthesizer oscillation frequency setting (frequency: Hz) Range: 0 (0Hz) to 100.0E+03 (100kHz) Resolution: 0.1E-03 (0.1mHz) Example: SFR 1.0E + 3 (1kHz)	Yes
<u>S</u> UB SYNTHESIZER <u>P</u> ERIOD	SBD	NR3	Sub synthesizer oscillation frequency setting (period: s) Range: 10.0E-06 (10ms=100kHz) to 10.0E+03 (10000s=0.1mHz) Resolution: 0.1E-06 (100ns) Example: SBD 1E + 2 (10s=0.01Hz)	Yes
<u>S</u> UB SYNTHESIZER <u>A</u> MPLITUDE <u>V</u> _{p-p} /OPEN	SAV	NR2	Sets sub synthesizer output amplitude (V _{p-p} /no load) Range: 0.2 (0.2V _{p-p} /no load) to 20.0 (20V _{p-p} /no load) Resolution: 0.1V _{p-p} /no load Example: SAV 5.0E + 00 (5V _{p-p} /no load)	Yes
<u>S</u> UB SYNTHESIZER <u>A</u> MPLITUDE <u>V</u> _{rms} /OPEN	SAR	NR3	Sets sub synthesizer output amplitude (V _{rms} /no load) Range: For \sim : 0.1(0.1V _{rms} /no load) to 7.0 (7.0V _{rms} /no load) For \sphericalangle , \sphericalangle , \sphericalangle : 0.1(0.1V _{rms} no load) to 5.7 (5.7V _{rms} /no load) For \sqcap : 0.1(0.1V _{rms} /no load) to 10.0 (10V _{rms} /no load) Resolution: 0.1V _{rms} /no load Example: SAR 6.2E+0 (6.2V _{rms} /no load)	Yes
<u>S</u> UB SYNTHESIZER <u>A</u> MPLITUDE <u>d</u> BV/OPEN	SAD	NR2	Sets sub synthesizer output amplitude (dBV/no load) Range: For \sim : -23.0 (-23.0dBV/no load) to 17.0 (17.0dBV/no load) For \sphericalangle , \sphericalangle , \sphericalangle : -24.7 (-24.7dBV/no load) to 15.2 (15.2dBV/no load) For \sqcap : -20.0 (-20.0dBV/no load) to 20.0 (20.0dBV/no load) Resolution: 0.1dBV/no load Example: SAD -2.3E+00 (-2.3dBV/no load)	Yes

Sub Synthesizer Parameter Setting Messages (Cont.)







Function	Program Code		Operation and Setting Range	Inquiry
	Header	Parameter		
SUB SYNTHESIZER FUNCTION	SBF	NR1	Selects sub synthesizer output waveform Range: 1 to 5 0: DC 1:  2:  3:  4:  5:  Example: SBF 2 ()	Yes Yes
SUB SYNTHESIZER PHASE	SPH	NR2	Sets sub synthesizer phase (°: deg) Range: -360.0 to 360.0 (-360° to 360°) Resoltuion: 0.1° Example: SPH 180.0 (180°)	Yes

Table 4-8. Main Synthesizer Trigger Parameter Setting Messages

Function	Program Code		Operation and Setting Range	Inquiry
	Header	Parameter		
TRIGGER SOURCE	TRS	NR1	Selects trigger source Range: 0 to 3 0: EXT ∇ 1: EXT \blacktriangle 2: INT ∇ 3: INT \blacktriangle Example: TRS 2 (triggered by ∇ of INT TRIG GEN)	Yes
REMOTE TRIGGER	TRG	NR1	Function equivalent to panel MAN key Effective only when trigger source is EXT (Burst: Trigger is performed when TRG 0 changes to TRG 1) Gate: Gate off when TRG 0 is specified. Gate on when TRG 1 is specified) Range: 0 or 1 0: Trigger inactive (Equivalent to MAN key off) 1: Trigger active (Equivalent to MAN key on) Example: TRG 1	Yes
STOP LEVEL	SPL	NR1	Selects stop level Range: 0 or 1 0: HOLD 1: RESET Example: SPL 1	Yes
MARK COUNT	MRK	NR2	Sets number of mark cycles (cycle) Range: 0.5 to 32768.0 Resolution: 0.5 cycle Example: MRK 10 (10 cycles)	Yes
SPACE COUNT	SPC	NR2	Sets number of space cycles Range: 0.5 to 32768.0 Resolution: 0.5 cycle Example: SPC 12.5 (12.5 cycle)	Yes
PHASE	PHS	NR2	Sets phase ($^{\circ}$: deg) Range: -360.0 to 360.0 (-360° to 360°) Resolution: 0.1° Example: PHS 270.0 (270°)	Yes
ϕ SYNC	SYN	None	Performs phase sync Example: SYN	No







Main Synthesizer Trigger Parameter Setting Messages (Cont.)

Function	Program Code		Operation and Setting Range	Inquiry
	Header	Parameter		
EXT TRIG IN BNC ENABLE	TRE	NR1	Enables EXT TRIG IN connector on front panel in remote mode. (This function becomes effective when trigger source is EXT and TRE 1 is received. In local mode, it is always effective. When remote mode is set again, status of previous remote mode is effective. TRE 1 is set at initial state when power is turned on, or when PST command is executed.) Range: 0 or 1 0: In remote mode, EXT TRIG IN connector is disabled. 1: In remote mode, EXT TRIG IN connector is enabled. Example: TRE 1	Yes

Table 4-9. Main Synthesizer Sweep Parameter Setting Messages

Function	Program Code		Operation and Setting Range	Inquiry
	Header	Parameter		
SWEEP <u>S</u> TART FREQUENCY	STF	NR3	Sets sweep start frequency (Frequency: Hz) Range: 0.0E+00 (0Hz) to 25.0E+06 (25MHz) Resolution: 0.1mHz Example: STF 1.0E+2 (100Hz)	Yes
SWEEP <u>S</u> TART PERIOD	STD	NR3	Sets sweep start frequency by period (period: s) Range: 40.0E-09 (40ns=25MHz) to 10.0E+03 (10000s=0.1mHz) Resolution: 1ns Example: STD 1.00E+0 (1s=1Hz)	Yes
SWEEP <u>S</u> TOP FREQUENCY	SPF	NR3	Sets sweep stop frequency (Frequency: Hz) Range: 0.0E+00 (0Hz) to 25.0E+06 (25MHz) Resolution: 0.1mHz Example: SPF 1.0E+2 (100Hz)	Yes
SWEEP <u>S</u> TOP PERIOD	SPD	NR3	Sets sweep stop frequency by period (period: s) Range: 40.0E-09 (40ns=25MHz) to 10.0E+03 (10000s=0.1mHz) Resolution: 1ns Example: STD 1.0E+0 (1s=1Hz)	Yes
SWEEP <u>C</u> ENTER FREQUENCY	CTF	NR3	Sets sweep center frequency (Frequency: Hz) Range: 0.0E+00 (0Hz) to 25.0E+06 (25MHz) Resolution: 0.1mHz Example: CTF 1.0E+2 (100Hz)	Yes
SWEEP <u>C</u> ENTER PERIOD	CTD	NR3	Sets sweep center frequency by period (Period: s) Range: 40.0E-09 (40ns=25MHz) to 10.0E+03 (10000s=0.1mHz) Resolution: 1ns Example: CTD 1.0000 (1s=1Hz)	Yes
SWEEP <u>S</u> PAN FREQUENCY	SNF	NR3	Sets sweep frequency span (Frequency: Hz) Range: 0.0E-03 (0 Hz) to 25.0E+06 (25MHz) Resolution: 0.1mHz Example: SNF 1.0E+2 (100Hz)	Yes

Main Synthesizer Sweep Parameter Setting Messages (Cont.)

Function	Program Code		Operation and Setting Range	Inquiry
	Header	Parameter		
SWEEP SPAN PERIOD	SND	NR3	Sets sweep frequency span by period (period: s) Range: 40.0E-09 (40ns=25MHz) to 10.0E+03 (10000s=0.1mHz) Resolution: 1ns Example: SND 1 (1s=1Hz)	Yes
SWEEP MARKER FREQUENCY	MKF	NR3	Sets sweep marker frequency (Frequency: Hz) Range: 0.0E+00 (0Hz) to 25.0E+06 (25MHz) Resolution: 0.1mHz Example: MKF 1.0E+2 (100Hz)	Yes
SWEEP MARKER PERIOD	MKD	NR3	Sets sweep marker frequency by period (period: s) Range: 40.0E-09 (40ns=25MHz) to 10.0E+03 (10000s=0.1mHz) Resolution: 1ns Example: MKD 1.0E+00 (1s=1Hz)	Yes
CENTER FROM MARKER	CFM	None	Assigns marker frequency to center frequency. (Assigns marker period to center period.)	No
SWEEP TIME	STM	NR3	Sets sweep time (s) Range: 5.0E-03 (5ms) to 9.999E+03 (9999s) Resolution: 1ms Example: STM 1.0E+00 (1s)	Yes
SWEEP FUNCTION	SFN	NR1	Selects sweep function Range: 0 to 4 0:  1: LIN  2: LIN  3: LOG  4: LOG  Example: SFN 2 (LIN )	Yes
SWEEP OFF	SOF	None	Disables sweep	No
SWEEP CONTINUOUS START	SCN	None	Starts continuous sweep	No
SWEEP SINGLE START	SSG	None	Starts single sweep	No

Main Synthesizer Sweep Parameter Setting Messages (Cont.)

Function	Program Code		Operation and Setting Range	Inquiry
	Header	Parameter		
<u>S</u> WEEP <u>S</u> TART <u>S</u> TATE	SST	None	Outputs start frequency (When this command is issued during sweep, sweep is stopped, and start frequency is output.)	No
<u>S</u> WEEP <u>S</u> TOP <u>S</u> TATE	SSP	None	Outputs stop frequency (When this command is issued during sweep, sweep is stopped, and stop frequency is output.)	No
<u>S</u> WEEP <u>H</u> OLD	HLD	None	Halts sweep	No
<u>S</u> WEEP <u>R</u> ESUME	RSM	None	Restarts sweep. (Even when RSM command is issued in other than HOLD state, it is ignored and not treated as an error.)	No
<u>S</u> INGL <u>S</u> TART <u>I</u> N <u>B</u> NC <u>E</u> NABLE	SGE	NR1	Enables SINGL START IN connector on rear panel in remote mode (In local mode, it is always enabled. When remote mode is set again, status of previous remote mode is effective. SGE 1 is set when power is first turned on, or when PST command is executed.) Range: 0 or 1 0: In remote mode, SINGL START IN connector is disabled. 1: In remote mode, SINGL START IN connector is enabled. Example: SGE 1	Yes
<u>H</u> OLD <u>I</u> N <u>B</u> NC <u>E</u> NABLE	HLE	NR1	Enables HOLD IN connector on rear panel in remote mode. (In local mode, it is always enabled. When remote mode is set again, status of previous remote mode is effective. HLE 1 is set when power is first turned on, or when PST command is executed.) Range: 0 or 1 0: In remote mode, HOLD IN connector is disabled. 1: In remote mode, HOLD IN connector is enabled. Example: HLE 0	Yes

NOTE: When the HOLD IN connector is enabled, the relationship between HOLD IN and the HLD or RSM command is as follows:

1. When the HOLD signal is applied to HOLD IN (low), the HLD and RSM commands have no effect. The sweep starts when the HOLD IN signal goes high.
2. While a sweep is halted by the HLD command, the HOLD IN connector is disabled. The sweep restarts when the RSM command is issued.

Table 4-10. Miscellaneous Parameter Messages

Function	Program Code		Operation and Setting Range	Inquiry
	Header	Parameter		
<u>D</u> UTY <u>C</u> YCLE	DTY	NR2	Sets square wave duty cycle (%) Range: 5.0 to 95.0 (5.0% to 95.0%) Resolution: 0.1% Example: DTY 12.5 (12.5%)	Yes
<u>D</u> UTY <u>C</u> YCLE <u>F</u> IXED	DYF	None	Sets square wave duty cycle at 50% (fixed) Example: DYF	No
<u>C</u> ALIBRATION	CAL	None	Performs main synthesizer output amplitude calibration Example: CAL	No
<u>C</u> ALIBRATION <u>A</u> BORT	CAB	None	Aborts main synthesizer output amplitude calibration Example: CAB	No
<u>B</u> EEP <u>O</u> N/ <u>O</u> FF	BEE	NR1	Selects beep sound ON/OFF Range: 0 or 1 0: OFF 1: ON Example: BEE 1 (beep sound ON)	Yes
<u>M</u> EMORY <u>S</u> TORE	STO	NR1	Stores setting conditions in memory. Range: 0 to 9 (Memory number) Example: STO 1	No
<u>M</u> EMORY <u>R</u> ECALL	RCL	NR1	Recalls setting conditions from memory. Range: 0 to 9 (Memory number) Example: RCL 9	No
<u>D</u> ISPLAY	DSP	None	Displays main synthesizer main parameters. Example: DSP	No
<u>S</u> UB <u>S</u> YNTHESIZER <u>D</u> ISPLAY	SDP	None	Displays sub synthesizer main parameters. Example: SDP	No
<u>F</u> CTN <u>S</u> IGNAL <u>O</u> N/ <u>O</u> FF	SIG	NR1	FCTN OUT on/off (turns output on/off) Range: 0 or 1 0: OFF 1: ON Example: SIG 1 (signal output ON)	Yes
<u>P</u> ANEL <u>K</u> EY <u>L</u> OCK <u>O</u> N/ <u>O</u> FF	LCK	NR1	Selects inhibition of panel key setting ON/OFF Range: 0 or 1 0: OFF (keys enabled) 1: ON (keys disabled) Example: LCK 1 (keys disabled)	Yes
<u>P</u> RESET	PST	None	Sets preset mode. Example: PST	No

Table 4-11. ARB Waveform Write and Readout Messages

Function	Program Code		Operation and Setting Range	Inquiry
	Header	Parameter		
<u>FORMAT</u>	FMT	NR1	Selects ARB waveform write and readout format Range: 0 or 1 0: ASCII format 1: Binary format Example: FMT 1	Yes
<u>START ADDRESS</u>	STT	NR1	Sets start ARB waveform write and readout address Range: 0000 to 1023 Example: STT 0 (Starts from address 0 for write or readout of ARB waveform.)	Yes
<u>WORD NUMBER</u>	WDN	NR1	Number of words for ARB waveform write and readout to be conducted Range: 0001 to 1024 Example: WDN 1024 (Performs 1024 words of ARB waveform write and readout from start address specified by STT command)	Yes
<u>WAVEFORM SET</u>	SET	None	Starts ARB waveform write Example: SET	No
<u>OUTPUT BLOCK SIZE</u>	BLK	NR1	Number of words per block for ASCII format ARB waveform readout Range: 0001 to 1024 Example: BLK 0512 (Performs 1 block of ARB waveform readout totalling 512 words)	Yes
<u>WAVEFORM OUTPUT</u>	OUT	None	Starts ARB waveform readout Example: OUT	No

Table 4-12. Parameters Specific to GPIB

Function	Program Code		Operation and Setting Range	Inquiry
	Header	Parameter		
<u>HEADER ON/OFF</u>	HDR	NR1	<p>Selects inclusion of header in inquiry message response.</p> <p>Range: 0 or 1</p> <p>0: No header is included in inquiry message response (off).</p> <p>1: Header is included in inquiry message response (on)</p> <p>Example: HDR 1</p>	Yes
<u>SRQ MASK</u>	MSK	NR1	<p>Sets SRQ mask.</p> <p>Range: 00 to 63</p> <p>32: Error occurred. (32: error SRQ 0: No Error SRQ)</p> <p>16: No effect (same as 0)</p> <p>8: No effect (same as 0)</p> <p>4: SWEEP stop (4: SWEEP stop. 0: No SWEEP stop.)</p> <p>2: SWEEP start (2: SWEEP start. 0: No SWEEP start.)</p> <p>1: Calibration is completed. (1: Calibration is completed. 0: Calibration is not completed.)</p> <p>Total of above SRQ causes is masked.</p> <p>Example: MSK 6 (6=4+2: SRQ is not issued when SWEEP stops or starts.)</p>	Yes

4.3.2 Model 3940 Inquiry Messages

When the header is on (HDR 1), each inquiry response will include a three-character identifying mnemonic. When the header is off (HDR 0), the first mnemonic not

sent, and only the parameter itself is transmitted. Each parameter begins with a space or minus sign (-) to indicate polarity.

Table 4-13. Main Synthesizer Parameter Inquiry Messages

Inquired Item	Program Code	Response Format	Setting
<u>F</u> REQUENCY Oscillation frequency (frequency: Hz)	?FRQ	NR3 format: Mantissa: 12 digits Exponent: 2 digits Example: FRQ 01.0000000000E+06 (1MHz)	Yes
<u>P</u> ERIOD Oscillation period (period: s)	?PRD	NR3 format: Mantissa: 6 digits Exponent: 2 digits Example: PRD 3.33333E-03 (3.33333ms=300Hz)	Yes
<u>A</u> AMPLITUDE (<u>V</u> _{p-p} /OPEN) Output amplitude (V _{p-p} /no load)	?AMV	NR3 format: Mantissa: 3 digits Exponent: 2 digits Example: AMV 10.0E+00 (10V _{p-p} /no load)	Yes
<u>A</u> AMPLITUDE <u>T</u> ERMINATE (<u>V</u> _{p-p} /50Ω) Output amplitude (V _{p-p} /50Ω)	?ATV	NR3 format: Mantissa: 3 digits Exponent: 2 digits Example: ATV 5.0E+00 (5V _{p-p} /50Ω)	Yes
<u>A</u> AMPLITUDE (<u>V</u> _{rms} /OPEN) Output amplitude (V _{rms} /no load)	?AMR	NR3 format: Mantissa: 3 digits Exponent: 2 digits Example: AMR 1.23E+00 (1.23V _{rms} /no load)	Yes
<u>A</u> AMPLITUDE <u>T</u> ERMINATE (<u>V</u> _{rms} /50Ω) Output amplitude (V _{rms} /50Ω)	?ATR	NR3 format: Mantissa: 3 digits Exponent: 2 digits Example: ATR 0.62E+00 (0.62V _{rms} /50Ω)	Yes
<u>A</u> AMPLITUDE (<u>d</u> BV/OPEN) Output amplitude (dBV/no load)	?AMD	NR3 format: Mantissa: 3 digits Exponent: 2 digits Example: AMD 01.0E+00 (1dBV/no load)	Yes

Main Synthesizer Parameter Inquiry Messages (Cont.)

Inquired Item	Program Code	Response Format	Setting
<u>AMPLITUDE TERMINATE</u> (dBV/50Ω) Output amplitude (dBV/50Ω)	?ATD	NR3 format: Mantissa: 3 digits Exponent: 2 digits Example: ATD -07.0E+00 (-7dBV/50Ω)	Yes
<u>AMPLITUDE TERMINATE</u> (dBm/50Ω) Output amplitude (dBm/50Ω)	?ATM	NR3 format: Mantissa: 3 digits Exponent: 2 digits Example: ATM -12.4E+00 (-12.4dBm/50Ω)	Yes
<u>OFFSET</u> DC offset voltage (V/no load)	?OFS	NR3 format: Mantissa: 3 digits Exponent: 2 digits Example: OFS -12.3E+00 (-12.3V/no load)	Yes
<u>OFFSET TERMINATE</u> DC offset voltage (V/50Ω)	?OFT	NR3 format: Mantissa: 3 digits Exponent: 2 digits Example: OFT -18.3E+00 (-18.3V/50Ω)	Yes
<u>FUNCTION</u> Output waveform	?FNC	NR1 format: One digit, same as setting value. Example: FNC 1 (∧)	Yes
<u>MODE</u> Operating mode	?MOD	NR1 format: One digit, same as setting value. Example: MOD 1 (BRST)	Yes

Table 4-14. Sub Synthesizer Parameter Inquiry Messages

Inquired Item	Program Code	Response Format	Setting
SUB SYNTHESIZER FREQUENCY Sub synthesizer oscillation frequency (frequency: Hz)	?SFR	NR3 format: Mantissa: 10 digits Exponent: 2 digits Example: SFR 100.0000000E+03 (100kHz)	Yes
SUB SYNTHESIZER PERIOD Sub synthesizer oscillation period (period: s)	?SBD	NR3 format: Mantissa: 6 digits Exponent: 2 digits Example: SBD 3.33333E-03 (3.33333ms=300Hz)	Yes
SUB SYNTHESIZER AMPLITUDE (V _{p-p} /OPEN) Sub synthesizer output amplitude (V _{p-p} /no load)	?SAV	NR2 format: Mantissa: 3 digits Example: SAV 10.0 (10V _{p-p} /no load)	Yes
SUB SYNTHESIZER AMPLITUDE (V _{rms} /OPEN) Sub synthesizer output amplitude (V _{rms} /no load)	?SAR	NR2 format: Mantissa: 3 digits Example: SAR 1.23 (1.23V _{rms} /no load)	Yes
SUB SYNTHESIZER AMPLITUDE (dVB/OPEN) Sub synthesizer output amplitude (dVB/no load)	?SAD	NR2 format: Mantissa: 3 digits Example: SAD 01.0 (1dVB.no load)	Yes
SUB SYNTHESIZER FUNCTION Sub synthesizer output waveform	?SBF	NR1 format: One digit, same as setting value. Example: SBF 2 ($\sqrt{\quad}$)	Yes
SUB SYNTHESIZER PHASE Sub synthesizer phase (°: deg)	?SPH	NR2 format: Mantissa: 4 digits Example: SPH -180.0 (-180.0°)	Yes

Table 4-15. Main Synthesizer Trigger Parameter Inquiry Messages

Inquired Item	Program Code	Response Format	Setting
<u>TRIGGER SOURCE</u> Trigger source	?TRS	NR1 format: One digit, same as setting value. Example: TRS 2 (INT ∇)	Yes
REMOTE <u>TRIGGER</u> Whether or not remote trigger is active	?TRG	NR1 format: One digit, same as setting value. Example: TRG 0	Yes
<u>STOP LEVEL</u> Stop level	?SPL	NR1 format: One digit, same as setting value. Example: SPL 0 (HOLD)	Yes
<u>MARK COUNT</u> Mark wave cycles (cycles)	?MRK	NR2 format: Mantissa: 6 digits Example: MRK 00128.0 (128 cycles)	Yes
<u>SPACE COUNT</u> Space wave cycles (cycles)	?SPC	NR2 format: Mantissa: 6 digits Example: SPC 00063.5 (63.5 cycles)	Yes
<u>PHASE</u> Phase (°: deg)	?PHS	NR2 format: Mantissa: 4 digits Example: PHS -270.0 (-270.0°)	Yes
EXT <u>TRIG IN BNC ENABLE</u> Inquiry on whether EXT TRIG IN connector on the front panel is enabled or not in remote mode	?TRE	NR1 format: One digit, same as setting value. Example: TRE 1 (Enabled)	Yes

Table 4-16. Main Synthesizer Sweep Parameter Inquiry Messages

Inquired Item	Program Code	Response Format	Setting
<u>SWEEP START FREQUENCY</u> Sweep start frequency (frequency: Hz)	?STF	NR3 format: Mantissa: 12 digits Exponent: 2 digits Example: STF 00100.0000000E+03 (100kHz)	Yes
<u>SWEEP START PERIOD</u> Sweep start period (period: s)	?STD	NR3 format: Mantissa: 6 digits Exponent: 2 digits Example: STD 3.33333E-03 (3.33333ms=300Hz)	Yes
<u>SWEEP STOP FREQUENCY</u> Sweep stop frequency (frequency: Hz)	?SPF	NR3 format: Mantissa: 12 digits Exponent: 2 digits Example: SPF 01.0000000000E+06 (1MHz)	Yes
<u>SWEEP STOP PERIOD</u> Sweep stop period (period: s)	?SPD	NR3 format: Mantissa: 6 digits Exponent: 2 digits Example: SPD 3.33333E-03 (3.33333ms=300Hz)	Yes
<u>SWEEP CENTER FREQUENCY</u> Sweep center frequency (frequency: Hz)	?CTF	NR3 format: Mantissa: 12 digits Exponent: 2 digits Example: CTF 00100.0000000E+03 (100kHz)	Yes
<u>SWEEP CENTER PERIOD</u> Sweep center period (period: s)	?CTD	NR3 format: Mantissa: 6 digits Exponent: 2 digits Example: CTD 3.33333E-03 (3.33333ms=300Hz)	Yes
<u>SWEEP SPAN FREQUENCY</u> Sweep span frequency (Frequency: Hz)	?SNF	NR3 format: Mantissa: 12 digits Exponent: 2 digits Example: SNF 01.0000000000E+06 (1MHz)	Yes
<u>SWEEP SPAN PERIOD</u> Sweep center period (period: s)	?SND	NR3 format: Mantissa: 6 digits Exponent: 2 digits Example: SND 3.33333E-03 (3.33333ms=300Hz)	Yes
<u>SWEEP MARKER FREQUENCY</u> Sweep marker frequency (Frequency: Hz)	?MKF	NR3 format: Mantissa: 12 digits Exponent: 2 digits Example: SNF 00100.0000000E+03 (100kHz)	Yes

Main Synthesizer Sweep Parameter Inquiry Messages (Cont.)

Inquired Item	Program Code	Response Format	Setting
<u>SWEEP MARKER PERIOD</u> Sweep marker period (period: s)	?MFD	NR3 format: Mantissa: 6 digits Exponent: 2 digits Example: SND 3.33333E-03 (3.33333ms=300Hz)	Yes
<u>SWEEP TIME</u> Sweep time (s)	?STM	NR3 format: Mantissa: 4 digits Exponent: 2 digits Example: STF 1.234E+00 (1.234s)	Yes
<u>SWEEP FUNCTION</u> Sweep function	?SFN	NR1 format 1 digit, same as setting value. Example: SFN 1 (LIN / 1)	Yes
<u>SINGL START IN BNC ENABLE</u> Whether or not SINGL START IN connector on rear panel is enabled in remote mode	?SGE	NR1 format: 1 digit, same as setting value. Example: SGE 1 (Enabled)	Yes
<u>HOLD IN BNC ENABLE</u> Whether or not HOLD IN connector on rear panel is enabled in remote mode	?HLE	NR1 format: 1 digit, same as setting value. Example: HLE 0 (Disabled)	Yes

Table 4-17. Inquiry Messages for Miscellaneous Parameters

Inquired Item	Program Code	Response Format	Setting
<u>D</u> UTY CYCLE Square wave duty cycle (%)	?DTY	NR2 format: Mantissa: 3 digits Example: DTY 25.0 (25%)	Yes
<u>D</u> UTY <u>V</u> AR/ <u>F</u> XD Inquiry on whether square wave duty cycle is variable or fixed at 50%	?DYV	NR1 format: 1 digit 0: Fixed 50% 1: Variable Example: DYV 1 (Variable)	Yes
<u>B</u> EEP ON/OFF Beep signal ON/OFF	?BEE	NR1 format: 1 digit, same as setting value. Example: BEE 0 (OFF)	Yes
<u>F</u> CTN <u>O</u> UT <u>S</u> IGNAL ON/OFF Signal output ON/OFF	?SIG	NR1 format: 1 digit, same as setting value. Example: SIG 1 (ON)	Yes
<u>P</u> ANEL <u>K</u> EY <u>L</u> OCK ON/OFF Panel key lock ON/OFF	?LCK	NR1 format: 1 digit, same as setting value. Example: LCK 1 (ON)	Yes

Table 4-18. Inquiry Messages for ARB Waveform Write and Readout Parameters

Inquired Item	Program Code	Response Format	Setting
<u>FORMAT</u> ARB Waveform write or readout formats	?FMT	NR1 format: 1 digit, same as setting value. Example: FMT 1 (Binary)	Yes
<u>START ADDRESS</u> ARB Waveform write or readout address	?STT	NR1 format: 4 digits, same as setting value Example: STT 0000 (Starts write and readout from 0 address.)	Yes
<u>WORD NUMBER</u> ARB Waveform write or readout word	?WDN	NR1 format: 4 digits, same as setting value. Example: WDN 1024 (Performs 1024 words of write and readout)	Yes
<u>OUTPUT BLOCK SIZE</u> Number of words for one block with readout of ARB waveform in ASCII format	?BLK	NR1 format: 4 digits, same as setting value. Example: BLK 0128 (Performs 1 block of ARB waveform readout totaling 128 words)	Yes

Table 4-19. Inquiry Messages for Parameters Specific to GPIB

Inquired Item	Program Code	Response Format	Setting
<u>HEADER ON/OFF</u> On/off state of header in inquiry message response	?HDR	NR1 format: 1 digit, same as setting value. Example: HDR 1 (on), 0 (off)	Yes
<u>SRQ MASK</u> SRQ mask setting (See Service Request in Section 4.2.2 Specifications)	?MSK	NR1 format: 2 digits, same as setting value Example: MSK 32 (All SRQs masked except error SRQ.)	Yes
<u>STATUS BYTE</u> Status byte readout	?STS	NR1 format: 3 digits 8-bit status byte is sent as decimal character string (000 to 127) Example: STS 122 (122=0111 1010)	No
<u>ERROR STATUS</u> Error number readout (See (15) Error Cord in Section 7.2.2 Specifications)	?ERR	NR1 format: 2 digits The latest error number is sent. If error number is read after the error is cleared, 00 is sent. Example: ERR 00 (Errors have been cleared.)	No
<u>UNIT IDENTIFICATION</u>	?IDT	NR1 format: 4 digits Example: IDT 3940	No

4.4 TYPICAL EXECUTION TIMES

The execution times shown in Table 4-20 are the times required from the reception of the command execution is complete. For inquiry messages, the execution time is the time required from reception of the command to the time when the output returns to the ready state. These execution times are applicable only when a sweep is not in progress. During a sweep, execution times may increase by a factor of from two to one hundred, depending on the sweep condition.

It takes about 0.5msec/byte for the Model 3940 to receive a command from GPIB. The execution times given in the table are those for which the number of message characters is the same as the number of characters returned by the corresponding inquiry.

It takes about 0.5msec/byte for the Model 3940 to transfer data in the talker mode.

Table 4-20. Typical Execution Times

Function		Setting Message Header	Typical Execution Time (ms)	Inquiry Message	Typical Execution Time (ms)
Main Synthesizer	Oscillation Frequency (Frequency:Hz)	FRQ	25	?FRQ	15
	Oscillation Frequency (period:s)	PRD	25	?PRD	15
	Output Amplitude (Vp-p/no load)	AMV	15	?AMV	10
	Output Amplitude (Vp-p/50Ω)	ATV	15	?ATV	10
	Output Amplitude (Vrms/no load)	AMR	15	?AMR	10
	Output Amplitude (Vrms/50Ω)	ATR	15	?ATR	10
	Output Amplitude (dBV/no load)	AMD	20	?AMD	10
	Output Amplitude (dBV/50Ω)	ATD	20	?ATD	10
	Output Amplitude (dBm/50Ω)	ATM	20	?ATM	10
	DC Offset Voltage (V/no load)	OFS	15	?OFS	10
	DC Offset Voltage (V/50Ω)	OFT	15	?OFT	10
	Output Waveform	FNC	10	?FNC	10
	Oscillation Mode	MOD	10	?MOD	10

Typical Execution Times (Cont.)

Function		Setting Message Header	Typical Execution Time (ms)	Inquiry Message	Typical Execution Time (ms)
Sub Synthesizer	Oscillation Frequency (Frequency:Hz)	SFR	25	?SFR	15
	Oscillation Frequency (period:s)	SBD	25	?SBD	15
	Output Amplitude (Vp-p/no load)	SAV	20	?SAV	15
	Output Amplitude (Vrms/no load)	SAR	20	?SAR	15
	Output Amplitude (dBV/no load)	SAD	30	?SAD	15
	Output Waveform	SBF	10	?SBF	10
	Phase (°: deg)	SPH	15	?SPH	15
Main Synthesizer Trigger	Trigger Source	TRS	15	?TRS	15
	Panel Key, Function corresponding to MAN	TRG	15	?TRG	15
	Stop Level	SPL	15	?SPL	15
	Mark Wave Cycles	MRK	15	?MRK	15
	Space Wave Cycles	SPC	15	?SPC	15
	Phase (°: deg)	PHS	15	?PHS	10
	Phase Sync	SYN	15	—	—
	EXT TRIG IN connector enable/disable in remote mode	TRE	15	?TRE	15

Typical Execution Times (Cont.)

Function		Setting Message Header	Typical Execution Time (ms)	Inquiry Message	Typical Execution Time (ms)
Main Synthesizer Sweep	Sweep Start Frequency (Frequency:Hz)	STF	25	?STF	15
	Sweep Start Period (Period:s)	STD	25	?STD	15
	Sweep Stop Frequency (Frequency:Hz)	SPF	25	?SPF	15
	Sweep Stop Period (Period:s)	SPD	25	?SPD	15
	Sweep Center Frequency (Frequency:Hz)	CTF	25	?CTF	15
	Sweep Center Period (Period:s)	CTD	25	?CTD	15
	Sweep Frequency Span (Frequency:Hz)	SNF	25	?SNF	15
	Sweep Frequency Span (Period:s)	SND	25	?SND	15
	Sweep Marker Frequency (Frequency:Hz)	MKF	25	?MKF	15
	Sweep Marker Frequency (Period:s)	MKD	25	?MFD	15
	Marker Frequency → Center Frequency	CFM	15	—	—
	Sweep Time (s)	STM	20	?STM	15
	Sweep Function	SFN	10	?SFN	10
	Sweep Off	SOF	15	—	—
	Continuous Sweep Start	SCN	(Note)	—	—
	Single Sweep Start	SSG	(Note)	—	—
	Sweep Start State	SST	10	—	—
	Sweep Stop State	SSP	10	—	—
	Sweep Hold	HLD	15	—	—
	Sweep Resume	RSM	15	—	—

Typical Execution Times (Cont.)

Function		Setting Message Header	Typical Execution Time (ms)	Inquiry Message	Typical Execution Time (ms)
Main Synthesizer Sweep (Cont.)	SINGL START IN connector enable/disable in remote mode	SGE	15	?SGE	10
	HOLD IN connector enable/disable in remote mode	HLE	15	?HLE	10
Miscellaneous	Square wave duty cycle (%)	DTY	15	?DTY	10
	Square wave duty cycle 50% fixed	DYF	10	—	—
	Inquiry on whether square wave duty cycle is variable or fixed at 50%	—	—	?DYV	10
	Main synthesizer output amplitude calibration	CAL	10	—	—
	Main synthesizer output amplitude calibration stop	CAB	100	—	—
	Beep ON/OFF	BEE	10	?BEE	10
	Store settings into memory	STO	25	—	—
	Recall settings from memory	RCL	50	—	—
	Main synthesizer main parameter display	DSP	15	—	—
	Sub synthesizer main parameter display	SDP	15	—	—
	FCTN OUT ON/OFF	SIG	15	?SIG	10
	Panel key lock ON/OFF	LCK	15	?LCK	10
	Preset state	PST	100	—	—

Typical Execution Times (Cont.)

Function		Setting Message Header	Typical Execution Time (ms)	Inquiry Message	Typical Execution Time (ms)
ARB Waveform Write and Readout	ARB waveform write and readout format	FMT	15	?FMT	10
	ARB waveform write and readout start address	STT	15	?STT	15
	Number of word for ARB waveform write and readout to be performed	WDN	20	?WDN	15
	ARB waveform readout start	SET	10	—	—
	Number of words per block for ASCII format ARB waveform readout	BLK	15	?BLK	10
	ARB waveform readout start	OUT	50	—	—
GPIB	Response header ON/OFF for inquiry messages	HDR	15	?HDR	10
	SRQ mask	MSK	15	?MSK	10
	Status byte readout	—	—	?STS	15
	Error number readout	—	—	?ERR	10
	System Unit ID inquiry	—	—	?IDT	10





NOTE: When sweep calculation is performed, execution time varies considerably depending on sweep conditions. Maximum sweep calculation time is about 100ms.

4.5 PROGRAM CODE SUMMARY TABLE

Table 4-21 shows the summary of the Model 3940 program codes.









In this table, the number of digits for response messages are expressed in the form of (number of digits for mantissa) + (number of digits for exponent). The number of digits for the exponent is always 2.

Table 4-21. Program Codes Summary

Function		Setting and Response Messages		Inquiry Message	Number of Digits for Response*
		Header	Parameter		
Main Synthesizer	Oscillation frequency (Frequency:Hz)	FRQ	NR3	?FRQ	12 + 2
	Oscillation Frequency (period:s)	PRD	NR3	?PRD	6 + 2
	Output Amplitude (Vp-p/no load)	AMV	NR3	?AMV	3 + 2
	Output Amplitude (Vp-p/50Ω)	ATV	NR3	?ATV	3 + 2
	Output Amplitude (Vrms/no load)	AMR	NR3	?AMR	3 + 2
	Output Amplitude (Vrms/50Ω)	ATR	NR3	?ATR	3 + 2
	Output Amplitude (dBV/no load)	AMD	NR3	?AMD	3 + 2
	Output Amplitude (dBV/50Ω)	ATD	NR3	?ATD	3 + 2
	Output Amplitude (dBm/50Ω)	ATM	NR3	?ATM	3 + 2
	DC Offset Voltage (V/no load)	OFS	NR3	?OFS	3 + 2
	DC Offset Voltage (V/50Ω)	OFT	NR3	?OFT	3 + 2
	Output Waveform 0: DC 1:  2:  3:  4:  5:  6: ARB	FNC	NR1	?FNC	1
	Oscillation Mode 0: CONT 1: BRST 2: TRIG 3: GATE	MOD	NR1	?MOD	1







*Mantissa digits + exponent digits

Program Codes Summary (Cont.)

Function		Setting and Response Messages		Inquiry Message	Number of Digits for Response*
		Header	Parameter		
Sub Synthesizer	Oscillation Frequency (Frequency:Hz)	SFR	NR3	?SFR	10 + 2
	Oscillation Frequency (Period:s)	SBD	NR3	?SBD	6 + 2
	Output Amplitude (Vp-p/no load)	SAV	NR2	?SAV	3
	Output Amplitude (Vrms/no load)	SAR	NR2	?SAR	3
	Output Amplitude (dBV/no load)	SAD	NR2	?SAD	3
	Output Waveform 1:  2:  3:  4:  5: 	SBF	NR1	?SBF	1
	Phase (°: deg)	SPH	NR2	?SPH	4
Main Synthesizer Trigger	Trigger Source 0: EXT  1: EXT  2: INT  3: INT 	TRS	15	?TRS	1
	Panel key, function corresponding to MAN 0: Trigger inactive 1: Trigger active	TRG	NR1	?TRG	1
	Stop Level 0: HOLD 1: RESET	SPL	NR1	?SPL	1
	Mark Wave Cycles	MRK	NR2	?MRK	6
	Space Wave Cycles	SPC	NR2	?SPC	6
	Phase (°: deg)	PHS	NR2	?PHS	4
	Phase Sync	SYN	—	—	—
	EXT TRIG IN connector enable/disable in remote mode 0: Disable 1: Enable	TRE	NR1	?TRE	1

*Mantissa digits + exponent digits

Program Codes Summary (Cont.)

Function		Setting and Response Messages		Inquiry Message	Number of Digits for Response
		Header	Parameter		
Main Synthesizer Sweep	Sweep Start Frequency (Frequency:Hz)	STF	NR3	?STF	12 + 2
	Sweep Start Period (Period:s)	STD	NR3	?STD	6 + 2
	Sweep Stop Frequency (Frequency: Hz)	SPF	NR3	?SPF	12 + 2
	Sweep Stop Period (Period:s)	SPD	NR3	?SPD	6 + 2
	Sweep Center Frequency (Frequency: Hz)	CTF	NR3	?CTF	12 + 2
	Sweep Center Period (Period:s)	CTD	NR3	?CTD	6 + 2
	Sweep Frequency Span (Frequency: Hz)	SNF	NR3	?SNF	12 + 2
	Sweep Frequency Span (Period: s)	SND	NR3	?SND	6 + 2
	Sweep Marker Frequency (Frequency: Hz)	MKF	NR3	?MKF	12 + 2
	Sweep Marker Period (Period: s)	MKD	NR3	?MFD	6 + 2
	Marker frequency substitute to center frequency	CFM	—	—	—
	Sweep Time (s)	STM	NR3	?STM	4 + 2
	Sweep Function 0:  1: LIN  2: LIN  3: LOG  4: LOG 	SFN	NR1	?SFN	1
	Sweep Off 	SOF	—	—	—
	Continuous Sweep Start	SCN	—	—	—
	Single Sweep Start	SSG	—	—	—
	Sweep Start State	SST	—	—	—
	Sweep Stop State	SSP	—	—	—
Sweep Hold	HLD	—	—	—	

Program Codes Summary (Cont.)

Function		Setting and Response Messages		Inquiry Message	Number of Digits for Response
		Header*	Parameter		
Main Synthesizer Sweep (Cont.)	Sweep Resume	RSM	—	—	—
	SINGL START IN connector enable/disable in remote mode 0: Enable 1: Disable	SGE	NR1	?SGE	1
	HOLD IN connector enable/disable in remote mode 0: Enable 1: Disable	HLE	NR1	?HLE	1
Miscellaneous	Square wave duty cycle (%)	DTY	NR2	?DTY	3
	Square wave duty cycle 50% fixed	DYF	—	—	—
	Inquiry on whether square wave duty cycle is variable or fixed at 50%	(DYV)	(NR1)	?DYV	1
	Main synthesizer output amplitude calibration	CAL	—	—	—
	Main synthesizer output amplitude calibration stop	CAB	—	—	—
	Beep ON/OFF	BEE	NR1	?BEE	1
	Store settings into memory	STO	NR1	—	—
	Recall setting from memory	RCL	NR1	—	—
	Main synthesizer parameter display	DSP	—	—	—
	Sub synthesizer main parameter display	SDP	—	—	—
	FCTN OUT ON/OFF	SIG	NR1	?SIG	1
	Panel key lock ON/OFF	LCK	NR1	?LCK	1
	Preset state	PST	—	—	—

*Parentheses indicate no setting message.

Program Codes Summary (Cont.)

Function		Setting and Response Messages		Inquiry Message	Number of Digits for Response
		Header*	Parameter		
ARB Waveform Write and Readout	ARB waveform write and readout format	FMT	NR1	?FMT	1
	ARB waveform write and readout start address	STT	NR1	?STT	4
	Number of words for ARB waveform write and readout to be performed	WDN	NR1	?WDN	4
	ARB waveform write start	SET	—	—	—
	Number of words for ASCII format ARB waveform readout	BLK	NR1	?BLK	4
	ARB waveform readout start	OUT	—	—	—
GPIB	Response header ON/OFF to inquiry messages 0: Off 1: On	HDR	NR1	?HDR	1
	SRQ Mask	MSK	NR1	?MSK	2
	Status byte readout	(STS)	NR1	?STS	3
	Error number readout	(ERR)	NR1	?ERR	2
	Unit ID inquiry	(IDT)	NR1	?IDT	4

*Parentheses indicate no setting message.

4.6 SAMPLE PROGRAMS

This section presents three sample programs to control the Model 3940 using an HP 9816 (or equivalent) personal computer as the controller. The primary address of the Model 3940 GPIB interface is assumed to be 2, and the delimiter is <CR><LF>.

Sample program 1 allows you to type in program codes and send them to the Model 3940. When the program code contains a "?", the Model 3940 is addressed to talk after the program code is transferred. The data is then read by the controller and displayed on the CRT. When an error occurs, a serial poll is performed, the error code is read, and an error message is displayed on the CRT.

Sample program 2 includes subroutines for transferring interface messages IFC, DCL, SDC, LLO, and GTL to the Model 3940 and the subroutines to set REN true or false.

Sample program 3 sets various parameters and inquires and displays settings.

Sample Program 1

```

100  PRINTER IS 1
110  DIM C#[80]
120  ON TIMEOUT 7,20 GOSUB 750
130  ABORT 7
140  CLEAR 7
150  REMOTE 702
160  OUTPUT 702;"MSK 31"
170  ON INTR 7 GOTO 280
180  !
190  ENABLE INTR 7;2
200  INPUT "INPUT PROGRAM CODE",C#
210  PRINT
220  PRINT "COMMAND = ",C#
230  OUTPUT 702;C#
240  IF POS(C#,"?") THEN GOSUB 780
250  FOR I=0 TO 500
260  NEXT I
270  GOTO 190
280  !
290  PRINT "** ERROR SERVICE ROUTINE **"

```

```

300  S=SPOLL(702)
310  OUTPUT 702;"?ERR"
320  ENTER 702;E#
330  OUTPUT 702;"?HDR"
340  ENTER 702;H#
350  IF H#="HDR 1" THEN
360    E=VAL(E#[4,6])
370  ELSE
380    E=VAL(E#)
390  END IF
400  SELECT E
410    CASE 1
420      PRINT " (ERROR 01) GPIB ERROR !"
430    CASE 2
440      PRINT " (ERROR 02) UNIT ERROR !"
450    CASE 3
460      PRINT " (ERROR 03) FREQ ERROR !"
470    CASE 4
480      PRINT " (ERROR 04) PHAS ERROR !"
490    CASE 5
500      PRINT " (ERROR 05) AMPT ERROR !"
510    CASE 6
520      PRINT " (ERROR 06) DFST ERROR !"
530    CASE 7
540      PRINT " (ERROR 07) ACDC ERROR !"
550    CASE 8
560      PRINT " (ERROR 08) FRDT ERROR !"
570    CASE 9
580      PRINT " (ERROR 09) SPLV ERROR !"
590    CASE 10
600      PRINT " (ERROR 10) MODE ERROR !"
610    CASE 11
620      PRINT " (ERROR 11) SWP ERROR !"
630    CASE 12
640      PRINT " (ERROR 12) RNGE ERROR !"
650    CASE 13
660      PRINT " (ERROR 13) CNVT ERROR !"
670    CASE 14
680      PRINT " (ERROR 14) MEMD ERROR !"
690    CASE 15
700      PRINT " (ERROR 15) SYNC ERROR !"
710    CASE 16
720      PRINT " (ERROR 16) CAL ERROR !"
730  END SELECT
740  GOTO 190
750  !
760  PRINT "** GP-IB Hang up **"
770  RETURN
780  !
790  ENTER 702;C#
800  PRINT " ANSWER = ",C#
810  RETURN
820  !
830  END

```

Sample Program 1 Description

Line	Description
100 to 170	Initializes controller and Model 3940.
100	Specifies CRT display.
110	Defines C\$ variable for 80 characters.
120	Sets interrupt time to 20 seconds.
130	Sends IFC.
140, 150	Sets REN true and sends DCL.
160	Sends MSK 31 to unit to enable SRQ on error.
170	Enables SRQ branching to line 280 on interrupt.
190 to 270	Loop to send program codes to Model 3940.
190	Enables controller SRQ interrupt.
200, 210	Inputs program code into C\$
220	Displays input program code.
230	Sends program code to Model 3940.
240	Executes specified subroutine when program code contains "?".
250, 260	Wait loop to ensure SRQ detection.
270	Returns to line 190.
290 to 740	Subroutine for generating SRQ interrupt.
300	Performs serial poll.
310, 320	Reads error code into E\$.
330, 340	Reads information on whether or not inquiry message has header (H\$).
350 to 390	Obtains error number (E).
400 to 730	Display error corresponding to error number E.
760, 770	Subroutine for displaying timeout.
790 to 810	Subroutine for reading and displaying unit settings.

Sample Program 2

```

100  !
110  !   *** IFC
120  ABORT 7
130  RETURN
140  !
150  !   *** DCL
160  CLEAR 7
170  RETURN
180  !
190  !   *** SDC
200  CLEAR 702
210  RETURN
220  !
230  !   *** LLD
240  LOCAL LOCKOUT 7
250  RETURN
260  !
270  !   *** GTL
280  LOCAL 702
290  RETURN
300  !
310  !   *** REN True
320  REMOTE 7
330  RETURN
340  !
350  !   *** REN False
360  LOCAL 7
370  RETURN
  
```

Sample Program

```

100  PRINTER IS 1
110  DIM C$(80)
120  ON TIMEOUT 7,20 GOTO 1040
130  ABORT 7
140  CLEAR 7
150  REMOTE 702
160  OUTPUT 702;"SOF; HDR 1"
170  !
180  OUTPUT 702;"FRQ 1000; ?FRQ"
190  ENTER 702;C#
200  PRINT "          ";C#
210  OUTPUT 702;"AMV 10.0E-03; ?AMV"
220  ENTER 702;C#
230  PRINT "          ";C#
240  OUTPUT 702;"OFS 0.0; ?OFS"
250  ENTER 702;C#
260  PRINT "          ";C#
270  OUTPUT 702;"FNC 1; ?FNC"
280  ENTER 702;C#
290  PRINT "          ";C#
300  OUTPUT 702;"MOD 0; ?MOD"
310  ENTER 702;C#
320  PRINT "          ";C#
330  !
340  PRINT
350  OUTPUT 702;"SFR 1000; ?SFR"
360  ENTER 702;C#
370  PRINT "          ";C#
380  OUTPUT 702;"SAV 0.2; ?SAV"
390  ENTER 702;C#
400  PRINT "          ";C#
410  OUTPUT 702;"SBF 1; ?SBF"
420  ENTER 702;C#
430  PRINT "          ";C#
440  OUTPUT 702;"SPH 0; ?SPH"
450  ENTER 702;C#
460  PRINT "          ";C#
470  !
480  OUTPUT 702;"SOF; STF 1000; SPF
10E3; MKF 5E3; STM 1; SFN 1"
490  PRINT
500  PRINT "          SWEEP OFF"
510  OUTPUT 702;"?STF"
520  ENTER 702;C#
530  PRINT "          ";C#
540  OUTPUT 702;"?SPF"
550  ENTER 702;C#
560  PRINT "          ";C#
570  OUTPUT 702;"?CTF"

```

Sample Program 3 Description

Line	Description
100 to 160	Initializes controller and Model 3940.
100	Specifies CRT display.
110	Sets C\$ for 80 characters.
120	Sets timeout interrupt time to 20 seconds.
130	Sends IFC.
140, 150	Sets REN true and sends DCL from controller.
160	Sends SOF (sweep on) and HDR (header on) to unit.
180 to 270	Sets and displays main synthesizer parameters.
180	Sets frequency to 1kHz and inquires setting.
190, 200	Reads and displays setting.
210	Sets amplitude to 10mVp-p and inquires setting.
240	Sets offset voltage to 0V and inquires setting.
270	Sets output waveform to sine and inquires setting.
300	Sets mode to CONT and inquires setting.
340 to 460	Sets and displays sub synthesizer parameters.
350	Sets frequency to 1kHz and inquires setting.
380	Sets amplitude to 10mVp-p and inquires setting.
410	Sets output waveform to sine and inquires setting.
440	Sets phase to 0° and inquires setting.
480 to 710	Sets and displays sweep parameters.
480	Sets sweep parameters.
490, 500	Makes display correspond to SOF.
510 to 710	Reads and display each sweep parameter.
730 to 920	Sets and displays trigger parameters.
730	Sets trigger parameters.
740 to 920	Reads and displays each trigger parameter.
940 to 1010	Sets and displays other parameters.
940	Sets other parameters.
950 to 1010	Reads and displays each parameter.
1030	Displays main synthesizer main parameters.

SECTION 4
GPIB Interface

```
580 ENTER 702;C#
590 PRINT " ";C#
600 OUTPUT 702;"?SNF"
610 ENTER 702;C#
620 PRINT " ";C#
630 OUTPUT 702;"?MKF"
640 ENTER 702;C#
650 PRINT " ";C#
660 OUTPUT 702;"?STM"
670 ENTER 702;C#
680 PRINT " ";C#
690 OUTPUT 702;"?SFN"
700 ENTER 702;C#
710 PRINT " ";C#
720 !
730 OUTPUT 702;"TRF 2; TRG 0; SPL 0;
MRK 1; SPC 1; PHS 0"
740 PRINT
750 OUTPUT 702;"?TRS"
760 ENTER 702;C#
770 PRINT " ";C#
780 OUTPUT 702;"?TRG"
790 ENTER 702;C#
800 PRINT " ";C#
810 OUTPUT 702;"?SPL"
820 ENTER 702;C#
830 PRINT " ";C#
840 OUTPUT 702;"?MRK"
850 ENTER 702;C#
860 PRINT " ";C#
870 OUTPUT 702;"?SPC"
880 ENTER 702;C#
890 PRINT " ";C#
900 OUTPUT 702;"?PHS"
910 ENTER 702;C#
920 PRINT " ";C#
930 !
940 OUTPUT 702;"DYF; BEE 1"
950 PRINT
960 OUTPUT 702;"?DYV"
970 ENTER 702;C#
980 PRINT " ";C#
990 OUTPUT 702;"?BEE"
1000 ENTER 702;C#
1010 PRINT " ";C#
1020 !
1030 OUTPUT 702;"DSP"
1040 END
```

APPENDIX A

Typical Data

INTRODUCTION

Appendix A provides the typical performance data for the Model 3940.

This instrument was thoroughly tested and inspected

and certified as meeting its published specifications when it was shipped from the factory. However, the typical data represents mean values of measurements for each Model 3940. Thus, measured performance of your Model 3940 may be different than that indicated by the typical data curves shown here.

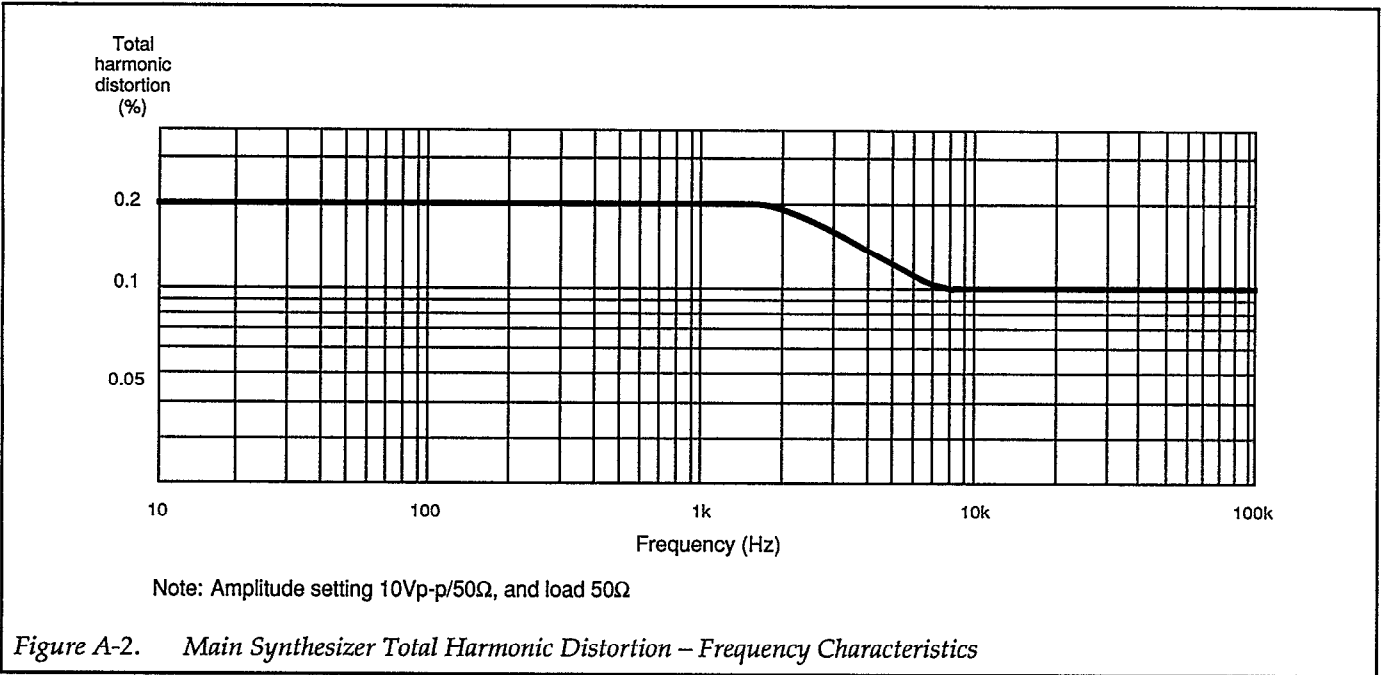
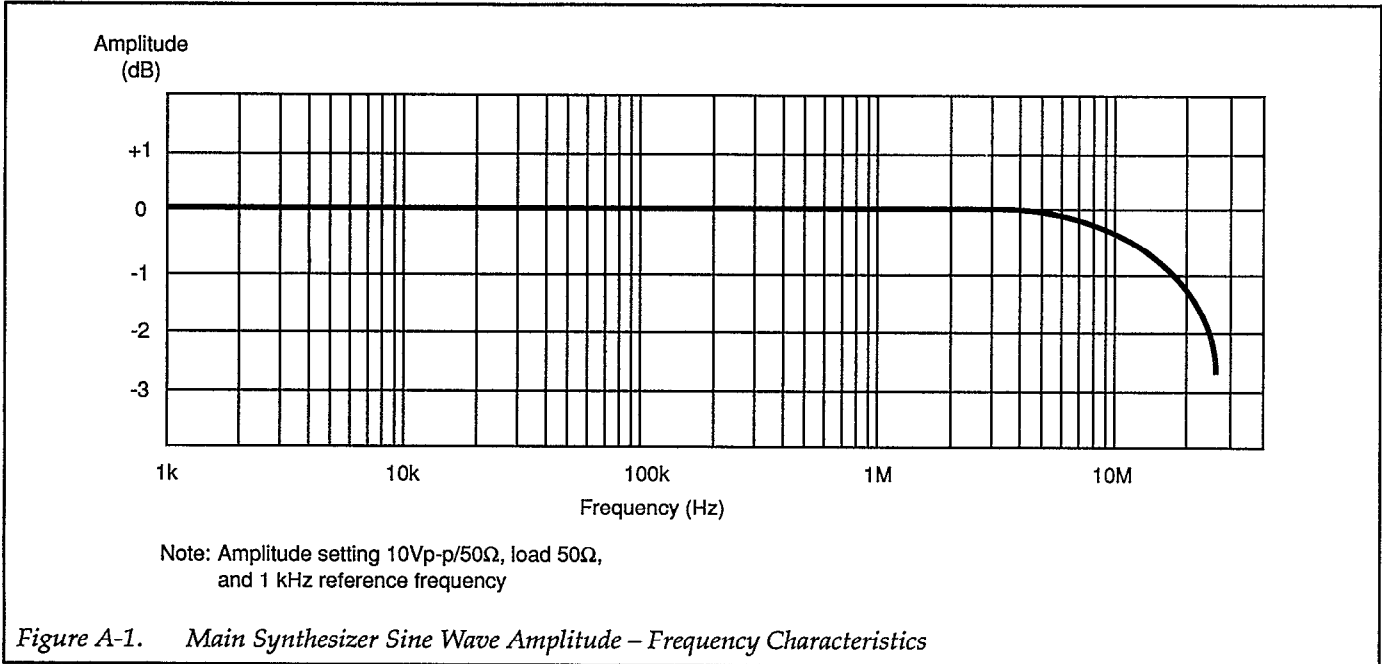

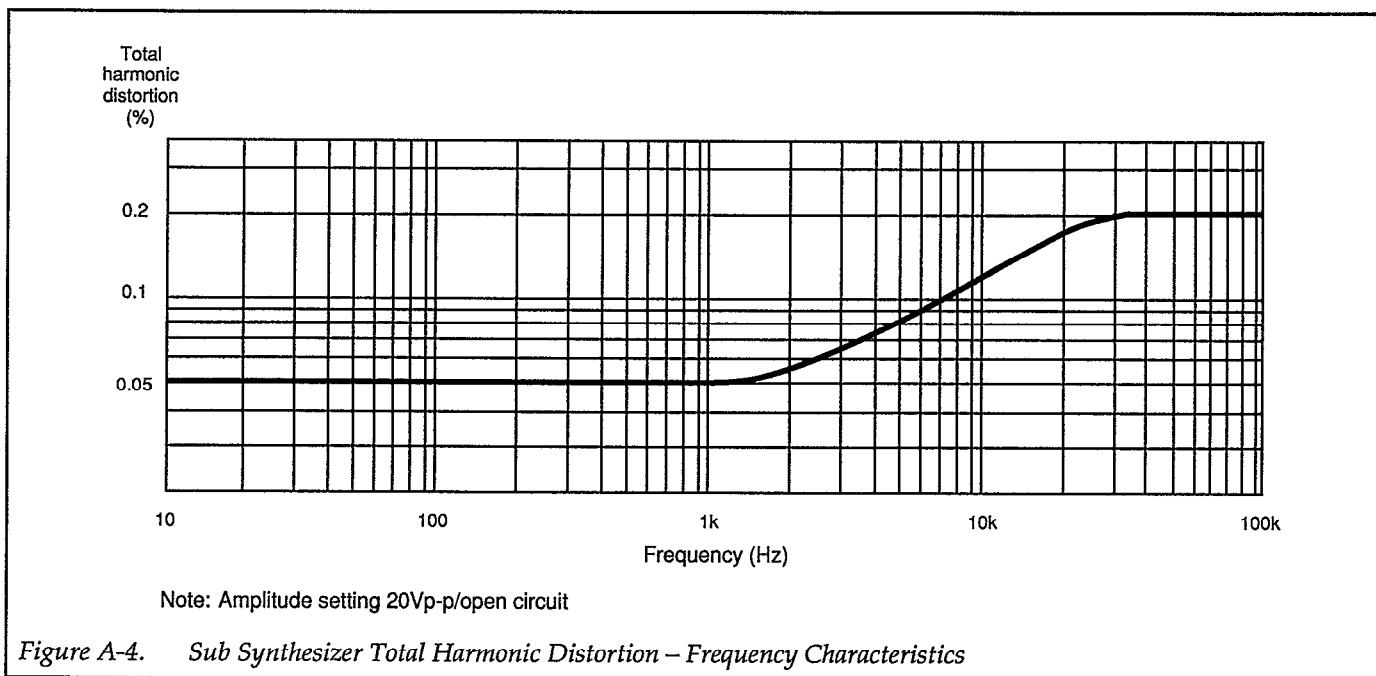
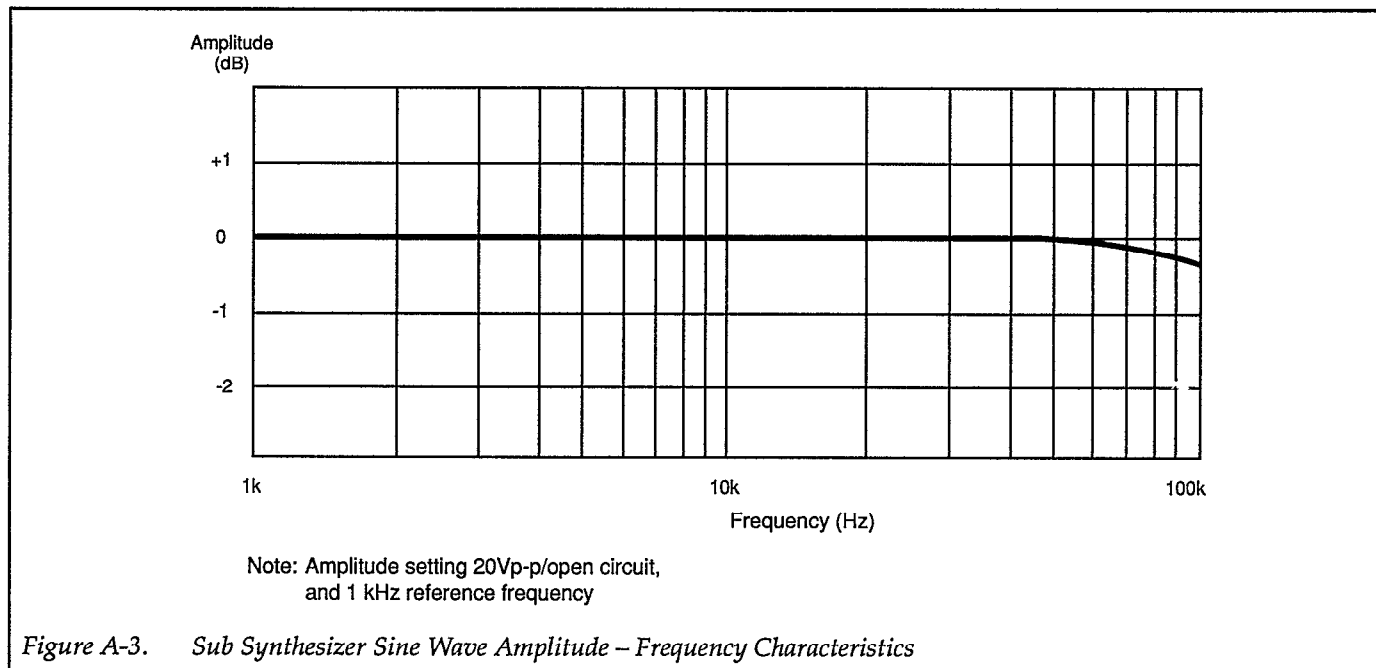





APPENDIX B

Model 3940 Specifications







B.1 ELECTRICAL SPECIFICATIONS

(Note: Items which are not denoted refer to the specifications of the main synthesizer.)

Waveforms		
Types	DC only,  ,  ,  ,  ,  , ARB	
ARB Waveform Input	Input	Data input with GPIB
	Address	0000 to 1023
	Data	-511 to +511

Oscillation Modes		
Continuous	CONT	Continuous oscillation
Burst	BRST	Repeating mark wave cycle (oscillation) and space wave cycle (stop) Mark wave cycle: 0.5 to 32768.0 (0.5 cycle resolution) Space wave cycle: 0.5 to 32768.0 (0.5 cycle resolution)
Trigger	TRIG	Mark wave cycle oscillation by trigger signals Mark wave cycle: 0.5 to 32768.0 (0.5 cycle resolution)
Gate	GATE	Oscillates in units of half cycles while trigger signal is ON.

Stop Level
HOLD: Stops at oscillation start phase. RESET: Stops at center value of the waveform. (Not applicable in CONT mode)

Frequency					
Frequency Range	Condition		General Specifications		
	Oscillation Modes, Stop Level	Waveforms	Specifications	Setting Range	
	CONT	 , Duty cycle is fixed at 50% 	0 to 20MHz	0 to 25MHz	
		Duty cycle is variable 	0 to 1MHz	0 to 1MHz	
		Other waveforms	0 to 1MHz	0 to 25MHz	
	BRST, TRIG, GATE	HOLD	 , Duty cycle is fixed at 50% 	0 to 10MHz	0 to 10MHz
			Duty cycle is variable 	0 to 1MHz	0 to 1MHz
			Other waveforms	0 to 1MHz	0 to 10MHz
		RESET	All waveforms	0 to 1MHz	0 to 1MHz
However, continuous output of the entire data of the ARB waveform is possible up to approximately 107kHz.					
Display	Max. 12 digits, resolution 0.1mHz (fixed)				
Accuracy	$\pm 5 \times 10^{-6}$ (± 5 ppm) (at 20°C to 30°C)				
Temperature Coefficient	$\pm 0.5 \times 10^{-6}/\text{C}$ typ. (± 0.5 ppm/C typ.)				
Stability	(24 hours after power on) $\pm 5 \times 10^{-6}/\text{year}$ (± 5 ppm/year)				
Setting in terms of period	Range	40ns to 10,000s			
	Display	Max. 6 digits, minimum resolution 1ns			
		Oscillates at a frequency that is reciprocal of the set period (digits smaller than 0.1mHz are truncated).			

Specifications subject to change without notice.

ELECTRICAL SPECIFICATIONS (CONT.)

Output Characteristics					
Maximum Output	AC only	20Vp-p/open, 10Vp-p/50Ω			
	DC only	±10V/open, ±5V/50Ω			
Display	Display switchable between open circuit voltage (/OPEN) and voltage into 50Ω load (/50Ω) However, for dBm, value displayed is always for a 50Ω load (/50Ω). For an arbitrary waveform the units are always Vp-p and the displayed voltage corresponds to the data values -511 and +511.				
	AC	Vp-p	Max. 3 digits	Minimum Resolution	0.01mVp-p/open
		Vrms	Max. 3 digits		0.01mVrms/open
		dBV	Max. 3 digits and minus sign		0.01mVrms/50Ω
		dBm	Max. 3 digits and minus sign		0.1dBV/open
	DC		Max. 3 digits and minus sign		0.1dBV/50Ω
				0.1mV/open	
				0.1mV/50Ω	
AC amplitude range for 0V DC offset		See Table B-1.			
AC amplitude resolution and accuracy for 0V DC offset		See Table B-2.			
Voltage range, resolution, and accuracy for DC only		See Table B-3.			
Minimum AC amplitude, resolution, and DC voltage accuracy for AC + DC		See Table B-4.			
Amplitude Frequency Characteristics	In CONT mode, 1kHz reference frequency, 0V DC offset, 50Ω load, and amplitude setting of 100mVp-p to 10Vp-p for waveforms other than \sim . (rms amplitude for \sim .)				
	\sim	Up to 1MHz	+0.3dB (RMS)		
		1MHz to 7MHz	+0.3, -0.5dB (RMS)		
		7MHz to 10MHz	+0.3, -1.0dB (RMS)		
		10MHz to 20MHz	+0.3, -2.5dB (RMS)		
\square	Up to 1MHz	±3% (p-p)			
(At duty cycle fixed/variable 50%)					
\sim	Up to 100kHz	±3% (p-p)			
\wedge, ∇	Up to 100kHz	±5% (p-p)			
\sim Spectrum purity	In CONT mode, 0V DC offset, 50Ω load, and 10.0Vp-p amplitude setting				
	Total Harmonic Distortion	10Hz to 100kHz	0.3% max		
	Harmonics	100kHz to 20MHz	-35dBc max		
	Spurious	up to 20MHz	-40dBc max		
\square Waveform Characteristics	50Ω load, 0V DC offset and 100mVp-p amplitude setting				
	Risetime, falltime	8ns max (15ns max in modes other than CONT mode, when stop level is RESET)			
	Overshoot, undershoot	5% max of output p-p amplitude			
	Duty cycle	(Not during sweep in CONT mode)			
		Accuracy for fixed duty cycle (50%)	up to 100kHz	±0.3% of period	
			100kHz to 1MHz	±2% of period	
Variable Range		5.0% to 95.0% (resolution 0.1%)			
	Accuracy	±1% of period (up to 1MHz), jitter 15ns max			
Output impedance	50Ω, unbalance				
Connector	BNC receptacle on front panel				

ELECTRICAL SPECIFICATIONS (CONT.)



Sync Output	
Output Voltage	TTL Level
Output impedance	Approximately 50Ω, unbalanced
Connector	BNC receptacle on front panel

Gate/Trigger Oscillation		
Trigger source	INT (internal)	Synchronizes with sub synthesizer output (positive/negative logic), manual triggering from front panel key, or remote triggering through GPIB
External trigger input	EXT (external)	Synchronized through external trigger input terminal (positive/negative logic), manual triggering from front panel key, or remote triggering through GPIB
	Input voltage	TTL Level (Input to 74LS14, pulled up by 4.7kΩ)
	Minimum pulse width	50ns
	Connector	BNC receptacle on front panel
Trigger delay	200ns max from external trigger input to waveform output 100ns max from sub synthesizer SYNC OUT to waveform output	
Trigger jitter	50ns max	



















External Add Input			
(An external signal input is added (summed) to main synthesizer waveform output).			
Gain of External Add Input	Total set ¹ Voltage (Peak)	Gain ² (/OPEN)	Gain ³ (/50Ω)
	1V to 10V	1	1/2
	100mV to 1V	1/10	1/20
	100mV to 10mV	1/100	1/200
	1mV to 10mV	1/1000	1/2000
Maximum External Input (V _{peak}) = 10 - Total Set Voltage/Gain			
¹ Total Set Voltage = $\frac{\text{Set AC Amplitude (V}_{p-p})}{2} + \text{Set DC Voltage (V)} $ Total Set Voltage = Set DC Voltage (V) when waveform is DC.			
² Gain = $\frac{\text{Main synthesizer output signal value}}{\text{External Add Input Signal value}}$			
³ Gain is 1/2 of the /OPEN value with a 50Ω load (/50Ω)			
Input impedance	Approx. 100kΩ		
Frequency range	DC to 1MHz		
Connector	BNC receptacle on rear panel		

Phase	
Range	-360° to 360°
Display	Max. 4 digits and minus sign, resolution 0.1 (fixed)
Oscillation start phase for burst/trigger/gate oscillation	
Oscillation will restart at this phase when the φ SYNC key is pressed or when the GPIB "SYN" command is given during independent or master operation.	
In addition, slave unit oscillation will restart at this phase when the φ SYNC key of the master unit is pressed or when the GPIB "SYN" command is given.	

ELECTRICAL SPECIFICATIONS (CONT.)

Synchronous Operation			
The synchronous operation mode can be selected by connecting the optional cable to PHASE SYNC I/O of multiple units. The master unit can control up to 3 slave units.			
Synchronous Operation Mode	Mode	Operation	PHASE SYNC I/O connections
	Single	Single unit operation	No connection
	Master	Transmit clock and ϕ SYNC pulse to slave unit	Connect with the optional synchronous cable (master connector).
	Slave	Operate with clock and ϕ SYNC pulse from the master unit	Connect with the optional synchronous cable (slave connector).
ϕ SYNC	Generates ϕ SYNC pulse to the PHASE SYNC I/O connector simultaneously when restarting oscillation of both main synthesizer and sub synthesizer during CONT mode.		
Clock and ϕ SYNC pulse delay time/unit		10ns max/unit	
Delay time from ϕ SYNC pulse to waveform output	Main synthesizer	 ,  (duty cycle fixed/variable 50%)	120ns max
		Other waveforms	80ns max
		Jitter	15ns max
	Sub synthesizer		3 μ s max
		Other waveforms	2 μ s max
		Jitter	350ns max
PHASE SYNC I/O connector	36-pin connector on rear panel		

ELECTRICAL SPECIFICATIONS (CONT.)

Frequency Sweep				
Sweep mode		Sweep functions	CONT (continuous sweep)	SINGL (single sweep)
			 or 	 or 
		LIN	 or 	 or 
			 or 	 or 
		LOG	 or 	 or 
Sweep range		Upper limit	Identical to ordinary oscillation	
		Lower limit	 , LIN	0Hz
			LOG	10.0mHz
Minimum sweep width		 , LIN	0.1mHz	
		LOG	1 octave (2 times)	
Sweep time		Range	5ms to 9999s	
		Display	Maximum 4 digits, minimum resolution 1ms	
Range setting		By setting start/stop frequencies or center/span frequencies		
Control		SINGL START	Starts single sweep	
		CONT START	Starts continuous sweep	
		SWEEP OFF	Halts sweep	
		START STATE	Sets output to the start frequency output state	
		STOP STATE	Sets output to the stop frequency output state.	
		HOLD/RESM	Holds and resumes sweep	
Other functions		Set marker frequency and substitute of marker frequency to center frequency		
Input	Single start input	Input voltage	TTL Level (Input of 74LS14 is pulled up by 4.7kΩ.)	
		Signal characteristics	Starts single sweep at the rising edge.	
		Minimum pulse width	50ns	
		Connector	BNC receptacle on rear panel	
	Hold input	Input voltage	TTL Level (Input to 74LS14 is pulled up by 4.7kΩ)	
		Signal characteristics	Low	Holds sweep
High		Resumes sweep (releases HOLD condition)		
Connector	BNC receptacle on rear panel			
Output	Sweep sync output	Output voltage	TTL Level (100Ω is connected in series to the output of 74LS14)	
		Signal characteristics	Low	Indicates that sweep from the start frequency to the stop frequency is in progress.
			High	Operation other than above
		Connector	BNC receptacle on rear panel	
	Marker output	Output voltage	TTL Level (100Ω is connected in series to the output of 74LS14)	
		Signal characteristics	Low	Indicates that a signal of which frequency is higher than the marker frequency is being output during sweep.
			High	Operation other than above.
		Connector	BNC receptacle on rear panel	
	X drive output	Output voltage	0V to +10V (/OPEN)	
		Signal characteristics	0V → 10V	Frequency increasing
			10V → 0V	Frequency decreasing
		Output impedance	Approx. 600Ω, unbalanced	
Load impedance		10kΩ minimum		
Connector	BNC receptacle on rear panel			

ELECTRICAL SPECIFICATIONS (CONT.)

Sub Synthesizer				
Waveforms				
Frequency	Frequency range	0 to 100kHz		
	Display	Max. 10 digits, resolution 0.1mHz (fixed)		
	Accuracy	Identical to main synthesizer (identical clock source)		
	Setting in terms of period	Range	10 μ s to 10000s	
		Display	Max. 6 digits, minimum resolution 100ns	
Oscillates at a frequency that is the reciprocal of the set period (the reciprocal is rounded to the nearest number below 0.1mHz).				
Output Characteristics	Amplitude range	20Vp-p/open to 0.2Vp-p/open		
	Display	Units	Display	Display resolution
		Vp-p/open	Max. 3 digits	0.1Vp-p/open (fixed)
		Vrms/open	Max. 3 digits	0.1Vrms/open (fixed)
		dBV/open	Max. 3 digits and minus sign	0.1dBV/open (fixed)
	Amplitude resolution	Approx. 78.4mVp-p/open (fixed)		
	Amplitude accuracy	At frequency 1kHz, 5Vp-p/open minimum		
			$\pm 3\%$ (rms)	
			$\pm 3\%$ (rms)	
	Amplitude vs. frequency characteristics	Referenced to 1kHz, amplitude setting 2Vp-p/open minimum		
		10Hz to 50kHz	± 0.3 dB (rms)	
		50kHz to 100kHz	+1.0dB, -2.0dB (rms)	
	Total Harmonic Distortion	Amplitude setting 20Vp-p/open		
10Hz to 20kHz		0.2% max		
20kHz to 100kHz		0.3% max		
Output Impedance	Approx. 600 Ω , unbalanced			
Load Impedance	10k Ω minimum			
Connector	BNC receptacle on front panel			
Sync output	Output voltage	TTL Level (100 Ω is connected in series to the output of a 74LS14)		
	Connector	BNC receptacle on front panel		
Phase	Range	-360° to 360°		
	Display	Max. 4 digits and minus sign, resolution 0.1° (fixed)		
	Oscillation will enter the resume phase when the ϕ SYNC key is pressed or when the GPIB "SYN" command is given during single or master operation. In addition, oscillation will enter the resume phase when the ϕ SYNC key of the master unit is pressed or when the GPIB "SYN" command is given during slave operation.			

ELECTRICAL SPECIFICATIONS (CONT.)

Memory	
Memory contents	<p>Main Synthesizer Frequency¹, AC amplitude², DC offset³, waveform, oscillation mode For sweep Frequencies of start¹, stop¹, center¹, span¹, marker¹, sweep time⁴, sweep function For trigger Trigger source, stop level, mark wave cycle⁴, space wave cycle⁴, phase⁴ Sub Synthesizer Frequency¹, AC amplitude⁵, waveform, phase⁴ Others □ Duty cycle⁴, 50% fixed/variable</p> <p>Notes: ¹Frequency display/terms of period display, cursor position and step size parameters saved. ²Voltage display with no load/display with 50Ω, display unit, cursor position and step size parameters saved. ³Voltage display with no load/display with 50Ω, cursor position and step size parameters saved. ⁴Cursor position and step size parameters saved. ⁵Display unit, cursor position and step size parameters saved.</p>
Number of memory units	10 units
Battery backup	30 days or more after full charge (stored at room temperature)

Storage of setting parameters at power off	
Functions	Parameters in effect prior to power-off are stored and become effective at next power-on.
Storage contents	Beep sound on/off, panel lock on/off, GPIB address, delimiter, and ARB waveforms, as well as items included in memory contents.
Battery backup	Identical to memory

ELECTRICAL SPECIFICATIONS (CONT.)

Preset

Sets the parameters listed below.

The modification step size is ± 1 . The underline indicates the cursor position.

Main Synthesizer

Frequency	<u>1</u> .0000000kHz (<u>1</u> .00000ms)
Amplitude	<u>1</u> 0.0mVp-p/open (<u>3</u> .54mVrms/open, - <u>4</u> 2.0dBV/no load, - <u>4</u> 2.0dBm/50 Ω)
DC offset	<u>0</u> .00mV/open
Waveform	<u>^</u>
Oscillation mode	CONT

For sweep

Start frequency	<u>1</u> .0000000kHz (<u>1</u> .00000ms)
Stop frequency	<u>1</u> 0.0000000kHz (<u>1</u> 00.00 μ s)
Center frequency	<u>5</u> .5000000kHz (<u>1</u> 81.818 μ s)
Frequency span	<u>2</u> .0000000kHz (<u>1</u> 11.111 μ s)
Marker frequency	<u>5</u> .0000000kHz (<u>2</u> 00.000 μ s)
Sweep time	<u>1</u> .000s
Sweep function	LIN <u>^</u>

For trigger

Trigger source	INT <u>^</u>
Stop level	HOLD
Mark wave cycle	<u>1</u> .0 cycle
Space wave cycle	<u>1</u> .0 cycle
Phase	<u>0</u> .0 deg

Sub Synthesizer

Frequency	<u>1</u> .0000000kHz (<u>1</u> .00000ms)
Amplitude	<u>1</u> .0Vp-p/open (0. <u>4</u> Vrms/open, - <u>8</u> .9dBV/open)
Waveform	<u>^</u>
Phase	<u>0</u> .0 deg

Others

<input type="checkbox"/> Duty cycle	50.0%
<input type="checkbox"/> Duty cycle 50%	
fixed/variable	fixed
Beep sound	ON

Display

Main parameter display of main synthesizer

ELECTRICAL SPECIFICATIONS (CONT.)

Modification			
Operation	By cursor movements with ◀ , ▶ keys (flashing display), and by increments/decrements with the Modify knob		
Increments/decrements with the Modify knob	Step size for cursor movement	± 1	Increases or decreases the cursor position value by 1.
		× + 2	Multiplies or divides the entire value by 2.
		× + 10	Multiplies or divides the entire value by 10.
	For waveform, oscillation mode, sweep function, trigger source, and stop level, the step size available is ±1 only and the cursor position is not displayed.		
Automatic repeat	Pressing the ◀ , ▶ keys for 0.3s or more causes automatic repeat.		
Non-modifiable parameters	Memory number, GPIB address, delimiter		

Signal Output ON/OFF			
Function	Simultaneously controls ON/OFF of FCTN OUT of the main synthesizer and the sub synthesizer. Factory default setting: Signal output ON at power-on.		
Operation	ON/OFF toggles each time the FCTN OUT ON/OFF key is pressed.		
OFF condition	Main synthesizer	FCTN OUT	Signal output will be open circuit.
		SYNC OUT	Identical to ON condition
	Sub synthesizer	FCTN OUT	Signal output will be 0V
		SYNC OUT	Signal output will stop oscillation at high level and low level

Other Functions	
Panel lock	Disables most front panel key entries and operating condition changes. Current parameter values can be displayed. GPIB input and certain BNC inputs are enabled.
Main synthesizer main parameter display	Main synthesizer frequency, waveform, oscillation mode, AC amplitude, DC offset, sweep condition are displayed together.
Sub synthesizer main parameter display	Sub synthesizer frequency, waveform, amplitude, phase are displayed together.
Calibration	Corrects main synthesizer AC amplitude error and offset error. FCTN OUT is OFF and SYNC OUT is undefined during calibration.
Beep sound ON/OFF	Controls ON/OFF of beep sound when panel keys are pressed (short beep), or when error has occurred (long beep).



B.2 GPIB INTERFACE



GPIB Interface		
Functions	SH1 AH1 T6 L4 SR1 RL1 PF0 DC1 DT0 C0	Full source handshaking capability Full acceptor handshaking capability Basic talker, serial poll, talker unaddressed if MLA Basic listener, unaddressed if MTA Full service request capability Full remote and local operation capability No parallel-polling function capability Full device clear capability No controller function capability No controller function capability
Data	ISO 7-bit code (ASCII code)	
Delimiter	Transmission	CR or CR/LF (selected by numeric keys on the panel) and EOI are sent simultaneously
	Reception	CR, CR/LF, CR + EOI, CR/LF + EOI, or EOI
Address	0 to 30 (selected by numeric keys on the panel)	
Output Driver	DIO1 to DIO8, NDAC, NRFD, SRQ	Open collector
	DAV, EOI	Tri-state
Local Key	Switch with return-to-local function	
Connector	IEEE-488 24-pin GPIB connector on rear panel	

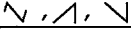

B.3 GENERAL

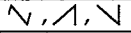

Signal Ground	The grounding pins of all input/output connectors are connected to the chassis.	
Power Supply	Voltage	100, 120, 220 or 240V AC $\pm 10\%$ (250V max)
	Frequency	48 to 62Hz
	Power Consumption	Approx. 70VA
Ambient Temperature and Humidity Ranges	Operating	0 to 40°C, 10 to 90% RH (without condensation)
	Storage	-10 to 50°C, 10 to 80% RH (without condensation)
Dimensions	Protruding parts not included	216 (W) \times 132.5 (H) \times 350 (D) mm
		8.5 (W) \times 5-1/4 (H) \times 13-3/4 (D) in.
Weight	Approx. 5.6kg (12.5 lbs.)	

Table B-1. AC Amplitude Range for 0V DC Offset

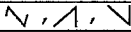
A. Values displayed with open load, Vrms units, in CONT mode			
AC Amplitude (p-p)	Output Waveforms		
			
20.Vp-p to 2.01Vp-p	7.07Vrms to 708.mVrms	5.77Vrms to 578.mVrms	10.0Vrms to 1.01mVrms
2.00Vp-p to 210.mVp-p	707.mVrms to 70.8mVrms	577.mVrms to 57.8mVrms	1.00mVrms to 101.mVrms
200.mVrmsVp-p to 20.1mVp-p	70.0mVrms to 7.08mVrms	57.7mVrms to 5.78mVrms	100.mVrms to 10.1mVrms
20.0mVp-p to 2.00mVp-p	7.07mVrms to 0.71mVrms	5.77mVrms to 0.58mVrms	10.0mVrms to 1.00mVrms

B. Values displayed with 50Ω load, Vrms units, in CONT mode			
AC Amplitude (p-p)	Output Waveforms		
			
10.0Vp-p to 1.01Vp-p	3.53Vrms to 354.mVrms	2.88Vrms to 289.mVrms	5.00Vrms to 501.mVrms
1.00Vp-p to 101.mVp-p	353.mVrms to 35.4mVrms	288.mVrms to 28.9mVrms	500.mVrms to 50.1mVrms
100.mVp-p to 10.1mVp-p	35.3mVrms to 3.54mVrms	28.8mVrms to 2.89mVrms	50.0mVrms to 5.01mVrms
10.0mVp-p to 1.00mVp-p	3.53mVrms to 0.36mVrms	2.88mVrms to 0.29mVrms	5.00mVrms to 0.50mVrms

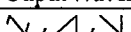
C. Values displayed with open load, dBV units, in CONT mode			
AC Amplitude (p-p)	Output Waveforms		
			
20.0Vp-p to 2.01Vp-p	16.9dBV to -3.0dBV	15.2dBV to -4.7dBV	20.0dBV to 0.1dBV
2.00Vp-p to 201.mVp-p	-3.1dBV to -23.0dBV	-4.8dBV to -24.7dBV	0.0dBVd to -19.9dBV
200.mVp-p to 20.1mVp-p	-23.1dBV to -43.0dBV	-24.8dBV to -44.6dBV	-20.0dBV to -39.9dBV
20.0mVp-p to 2.00mVp-p	-43.1dBV to -63.0dBV	-44.8dBV to -64.7dBV	-40.0dBV to -60.0dBV

D. Values displayed with 50Ω load, dBV units, in CONT mode			
AC Amplitude (p-p)	Output Waveforms		
			
10.0Vp-p to 1.01Vp-p	10.9dBV to -9.0dBV	9.2dBV to -10.7dBV	13.9dBV to -6.0dBV
1.00Vp-p to 101.mVp-p	-9.1dBV to -29.0dBV	-10.8dBV to -30.7dBV	-6.1dBV to -26.0dBV
100.mVp-p to 10.1mVp-p	-29.1dBV to -49.0dBV	-30.8dBV to -50.7dBV	-26.1dBV to -46.0dBV
10.0mVp-p to 1.00mVp-p	-49.1dBV to -69.0dBV	-50.8dBV to -70.7dBV	-46.1dBV to -66.0dBV



E. Values displayed with 50Ω load, dBm units, in CONT mode			
AC Amplitude (p-p)	Output Waveforms		
			
10.0Vp-p to 1.01Vp-p	23.9dBm to 4.0dBm	22.2dBm to 2.3dBm	26.9dBm to 7.0dBm
1.00Vp-p to 101.mVp-p	3.9dBm to -16.0dBm	2.2dBm to -17.7dBm	6.9dBm to -13.0dBm
100.mVp-p to 10.1mVp-p	-16.1dBm to -36.0dBm	-17.8dBm to -37.7dBm	-13.1dBm to -33.0dBm
10.0mVp-p to 1.00mVp-p	-36.1dBm to -56.0dBm	-37.8dBm to -57.7dBm	-33.1dBm -53.0dBm

Table B-2. AC Amplitude Resolution and Accuracy for 0V DC Offset (OPEN load)

Open load, CONT mode, frequency up to 10kHz, temperature within $\pm 5^{\circ}\text{C}$ of calibration temp.				
Output Amplitude Display	Amplitude Resolution	Amplitude Accuracy (RMS)		Output Attenuator
			All Other Waveforms	
$20\text{Vp-p} \geq \text{display} > 2.00\text{mVp-p}$	10mVp-p	$\pm 2\%$	$\pm 3\%$	1/1
$2.00\text{Vp-p} \geq \text{display} > 200\text{mVp-p}$	1mVp-p	$\pm 4\%$	$\pm 5\%$	1/10
$200\text{mVp-p} \geq \text{display} > 20.0\text{mVp-p}$	100 $\mu\text{Vp-p}$	$\pm 6\%$	$\pm 7\%$	1/100
$20.0\text{mVp-p} \geq \text{display} > 2.00\text{mVp-p}$	10 $\mu\text{Vp-p}$	Not Specified		1/1000

Table B-3. Voltage Range, Resolution, and Accuracy for DC Only (OPEN load)

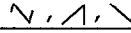
DC (+ or -)	Resolution	Accuracy	Output Attenuator
10.0V to 1.01V	5.0mV	$\pm(1\% + 20\text{mV})$	1/1
1.00V to 101.mV	500 μV	$\pm(2\% + 2\text{mV})$	1/10
100.mV to 10.0mV	50 μV	$\pm(3\% + 0.2\text{mV})$	1/100
10.0mV to 0.00mV	5.0 μV	Not specified	1/1000

Table B-4. Minimum AC Amplitude, Resolution, and DC Voltage Accuracy for AC + DC (OPEN load)

Open load, CONT mode, frequency up to 10kHz, temperature within $\pm 5^{\circ}\text{C}$ of calibration temperature				
Total Set Voltage*	>1V	>100mV	>10mV	$\leq 10\text{mV}$
Minimum AC Amplitude	200mVp-p	20mVp-p	2mVp-p	2mVp-p
AC Amplitude Resolution	10mVp-p	1mVp-p	0.1mVp-p	10mVp-p
DC Voltage Resolution	5mVp-p	0.5mVp-p	50 μ Vp-p	5mVp-p
DC Voltage Accuracy	When AC amplitude is $>2.00\text{V} \pm(0.5\%$ of AC amplitude + 1% of DC offset voltage +20mV)	When AC amplitude is $>200\text{mV} \pm(0.5\%$ of AC amplitude + 2% of DC offset voltage +2mV)	When AC amplitude is $>20.0\text{mV} \pm(0.5\%$ of AC amplitude + 3% of DC offset voltage +0.2mV)	Not Specified
	When AC amplitude is $\leq 2.00\text{V} \pm(1\%$ of AC amplitude +2% of DC offset voltage +40mV)	When AC amplitude is $\leq 200\text{mV} \pm(1\%$ of AC amplitude +3% of DC offset voltage +4mV)	When AC amplitude is $\leq 20.0\text{mV} \pm(1\%$ of AC amplitude +4% of DC offset voltage +0.4mV)	Not specified
Output Attenuator	1/1	1/10	1/100	1/1000
$*\text{Total Set Voltage} = \frac{\text{Set AC Amplitude (Vp-p)}}{2} + \text{Set DC Voltage (V)} $				

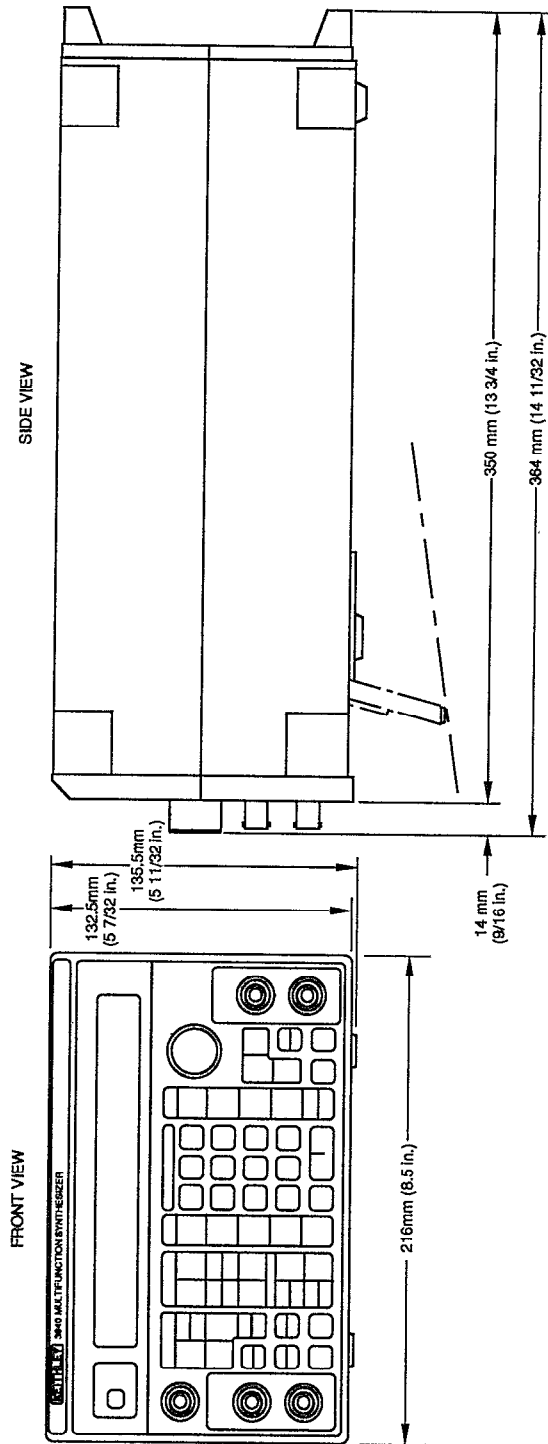

Figure B-1. Outer Dimensions of the Model 3940

Index

A

AC Amplitude and DC Offset Relational Restrictions, 3-24
Amplitude Programming, 3-23
Amplitude Units Conversion, 3-22
Analog Input, 3-14
Analog Outputs, 3-15
ARB Waveform Write and Readout Operations, 4-9

B

BASIC OPERATION, 2-3
Basic Controller Functions, 4-4
Basic Listener Functions, 4-4
Basic Talker Functions, 4-3
Burst Mode, 3-28
Bus Driver, 4-6
Bus Line Signals, 4-2

C

Codes, 4-6
Continuous Mode, 3-28
Continuous Sweep, 3-35

D

DC Offset Programming, 3-23
Delimiter, 4-7

E

Error Codes, 3-18, 4-13

F

Fan, 2-1
FEATURES, 1-1
Frequency Programming, 3-22
Frequency Sweep Operation, 3-34
Frequency Units Conversion, 3-22
Front Panel Description, 3-1
Front Panel Summary, 2-3

G

Gate Mode, 3-29
GPIB Handshaking, 4-2
GPIB Overview, 4-1
GPIB Primary Address, 4-6
GPIB Specifications, 4-1

H

HANDLING PRECAUTIONS, 2-3
Holding/Resuming a Sweep, 3-38

I

INSTALLATION, 2-1
Input Connections, 3-14

Inquiry Messages, 4-8
Interface Functions, 4-6

L

Line Fuse, 2-2
Line Receptacle Connection, 2-2
Line Voltage Selector Switch, 2-2
Linear Sweep Steps, 3-39
Log Sweep Steps, 3-40
Logic Inputs, 3-14
Logic Outputs, 3-15

M

MANUAL ADDENDA, 1-2
Mark and Space Parameter Programming, 3-29
MODIFY, 3-18
Model 3940 Parameter-Setting Messages, 4-13
Multi-Line Interface Messages, 4-4

N

Numeric Keys, 3-17

O

OPTIONAL ACCESSORIES, 1-3
Operating Examples, 2-5
Oscillation Mode Selection, 3-28
Output Connections, 3-15

Output Considerations, 3-16
OVERVIEW OF MODEL 3940 GPIB INTER-
FACE, 4-6

P

Parameter Setting Messages, 4-7
Phase, 3-30
PROGRAM CODE SUMMARY TABLE, 4-40
Program Codes, 4-7

R

Rear Panel Description, 3-12
Repacking, 1-2
Response to Interface Messages, 4-7

S

SAFETY TERMS AND SYMBOLS, 1-2
SAMPLE PROGRAMS, 4-45
Service Request (SRQ), 4-11
Single Sweep, 3-35
Square-Wave Duty Cycle, 3-26
STARTUP, 3-16
Start Frequency, 3-38
Status Byte, 4-12
Stop Frequency, 3-38
Stop Level Selection, 3-32
Substituting Marker Frequency, 3-39
Sweep Frequency and Sweep Output, 3-39
Sweep Operations, 3-35
Sweep Range, 3-34
Sweep Time, 3-35
SYNC, 3-32
Synchronous Operation, 3-34
Synchronous Output, 3-26

T

Trigger Mode, 3-28
Trigger Source Selection, 3-29
Turning a Sweep Off, 3-38
TYPICAL EXECUTION TIMES, 4-35
Typical Data, A-1
Typical Test Connections, 2-3

U

Units Conversion, 3-22
Unpacking, 1-2

W

WARRANTY INFORMATION, 1-2
Waveform Selection, 3-26

KEITHLEY INSTRUMENTS

SERVICE FORM

Model No. _____ Serial No. _____ Date _____

Name and Telephone No. _____

Company _____

List all control settings, describe problem and check boxes that apply to problem. _____

- Intermittent Analog output follows display Particular range or function bad; specify _____
 IEEE failure Obvious problem on power-up Batteries and fuses are OK
 Front panel operational All ranges or functions are bad Checked all cables

Display or output (circle one)

- Drifts Unable to zero
 Unstable Will not read applied input
 Overload

- Calibration only Certificate of Calibration required
 Data required

(attach any additional sheets as necessary.)

Show a block diagram of your measurement system including all instruments connected (whether power is turned on or not). Also, describe signal source.

Where is the measurement being performed? (factory, controlled laboratory, out-of-doors, etc.)

What power line voltage is used? _____ Ambient Temperature? _____ °F

Relative humidity? _____ Other? _____

Any additional information. (If special modifications have been made by the user, please describe.) _____

Be sure to include your name and phone number on this service form.

KEITHLEY INSTRUMENTS

Instruments Division, Keithley Instruments, Inc. • 28775 Aurora Road • Cleveland, Ohio 44139 • (216) 248-0400 • Fax: 248-6168

WEST GERMANY: Keithley Instruments GmbH • Heighofstr. 5 • Munchen 70 • 089-71002-0 • Telex: 52-12160 • Fax: 089-7100259
GREAT BRITAIN: Keithley Instruments, Ltd. • The Minster • 58, Portman Road • Reading, Berkshire RG 3 1EA • 011 44 734 575 666 • Fax: 011 44 734 596 469
FRANCE: Keithley Instruments SARL • 3 Allée des Garays • B.P. 60 • 91124 Palaiseau/Z.I. • 1-6-0115 155 • Telex: 600 933 • Fax: 1-6-0117726
NETHERLANDS: Keithley Instruments BV • Avelingen West 49 • 4202 MS Gorinchem • P.O. Box 559 • 4200 AN Gorinchem • 01830-35333 • Telex: 24 684 • Fax: 01830-30821
SWITZERLAND: Keithley Instruments SA • Kriesbachstr. 4 • 8600 Dubendorf • 01-821-9444 • Telex: 828 472 • Fax: 0222-315366
AUSTRIA: Keithley Instruments GesmbH • Rosenhugelstrasse 12 • A-1120 Vienna • (0222) 84 65 48 • Telex: 131677 • Fax: (0222) 8403597
ITALY: Keithley Instruments SRL • Viale S. Gimignano 4/A • 20146 Milano • 02-4120360 or 02-4156540 • Fax: 02-4121249